



300 HUEY LENARD LOOP | WEST MONROE | LA 71292  
OFFICE: 318-397-3000 | FAX: 318-397-3040  
SERVICE & TECH SUPPORT: 800-551-4955  
SUPERLIFT.COM

# 2016-2021 NISSAN TITAN 6" LIFT KIT INSTALLATION INSTRUCTIONS



**MAKE SURE YOU HAVE THE CORRECT LIFT FOR YOUR VEHICLE:  
Double check the Year, Make, Model, Lift Height and KIT Part Numbers.**

Prior to beginning the installation, OPEN the boxes and CHECK the included components compared to the parts breakdown. Check all parts and hardware in the box with the parts list below. Be sure you have all needed parts and know where they install.

If you find a packaging error, contact SUPERLIFT directly. Do not contact the dealer where the system was originally purchased. You will need the control number from each box when calling; this number is located at the bottom of the part number label and to the right of the bar code.

# THANK YOU FOR CHOOSING SUPERLIFT FOR ALL YOUR SUSPENSION NEEDS!!

**Read And Understand All Instructions And Warnings Prior To Installation Of System AND Operation Of Vehicle.**

## **INTRODUCTION BEFORE INSTALLATION**

Installation requires a professional mechanic. In addition to these instructions, professional knowledge of disassembly / reassembly procedures and post installation checks must be known.

PRIOR to beginning, inspect the vehicles steering, driveline, and brake systems, paying close attention to the suspension link arms and bushings, sway bars and bushings, tie rod ends, pitman arm, idler arm, ball joints and wheel bearings. Also check the steering sector-to-frame and all suspension-to-frame attaching points for stress cracks. The overall vehicle must be in excellent working condition; repair or replace all worn parts.

Read instructions several times before starting.

Read each step completely as you go.

## **Be sure you have all needed parts and know where they install**

- Recommended wheel is 18" diameter not exceeding 9" wide with 5" of backspacing.
- Do NOT install this suspension system in conjunction with any other type of aftermarket or fabricated components to gain additional suspension height.
- Do not fabricate any components to gain additional suspension height.
- Prior to drilling and/or cutting, check behind the surface being worked on for any wires, lines, or hoses that could be damaged. Prep all cutting surfaces by removing all debris and frame coatings. After drilling and/or cutting, file smooth any burrs and sharp edges.
- Prior to operating a torch or saw, protect any heat-sensitive components located in the immediate area by covering them with a water-saturated cloth. Most undercoating are flammable but can be extinguished using a water-filled spray bottle. Have a spray bottle and an ABC rated fire extinguisher on hand.
- Paint or undercoat all exposed metal surfaces.
- Prior to attaching components, be sure all mating surfaces are free of grit, grime, grease, undercoating, etc.
- Front end alignment is necessary.
- Tool and Wrench/Socket size is given in brackets [ ] after each appropriate step.
- A foot-pound torque reading is given in parenthesis ( ) after each appropriate fastener.
- Always wear safety glasses when using power tools.
- A factory service manual should be on hand for reference.
- Due to payload options and initial ride height variances, the amount of lift is a 'base figure'. Final ride height dimensions may vary in accordance to original vehicle stance.

**BEFORE YOU DRIVE**

Check all fasteners for proper torque. Check to ensure for adequate clearance between all rotating, mobile, fixed, and heated members. Verify clearance between exhaust and brake lines, fuel lines, fuel tank, floor boards and wiring harness. Check steering components for clearance.

Test and inspect brake system. Perform steering sweep to ensure front brake hoses have adequate slack and do not contact any rotating, mobile or heated members. Inspect rear brake hoses at full extension for adequate slack. Failure to perform hose check/replacement may result in component failure.

**Perform head light check and adjustment.**

It is the ultimate buyer's responsibility to have all bolts and nuts checked for tightness after the first 100 miles and then every 1000 miles. The steering, suspension and driveline systems, plus wheel alignment should be inspected by a qualified professional mechanic at least every 3000 miles.

**TIRES AND WHEELS**

It is recommended that a 285/70 R17 tire is used.

Any larger or wider tire and wheel combination other than listed may require vehicle trimming.

ALL tire and wheel combinations should be test fit prior to installation. Some minor trimming may be required.

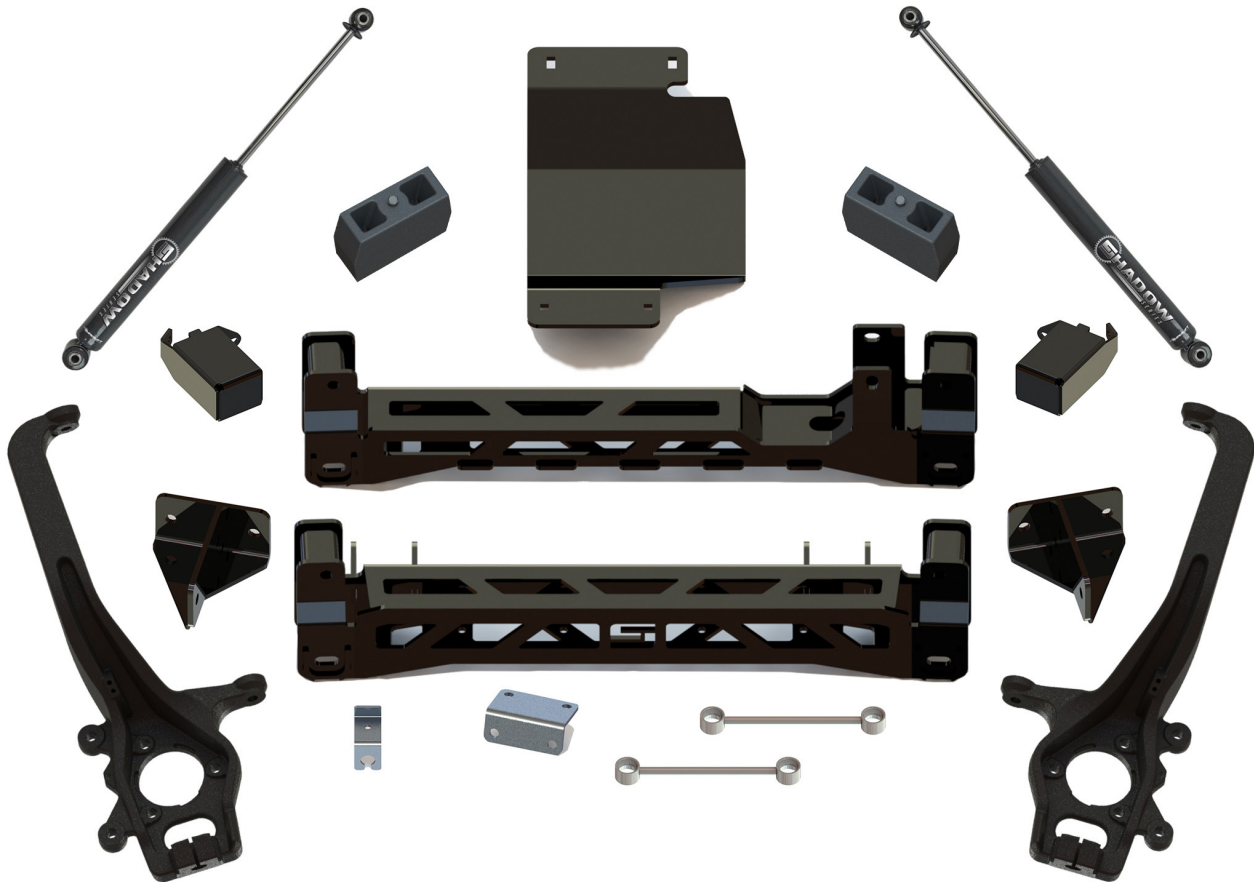



STEP	PART NUMBER	QTY. PER KIT	DESCRIPTION	NEW ATTACHING HARDWARE	QTY. PER BRACKET	HARDWARE BAG NUMBER
<b>FRONT</b>						
45	55-35-6200	1	Front Crossmember	55-16-6200 - cam bolt	2	77-6201A
				55-15-6200 - cam washer	4	
				55-45-6200 - lockout plate	4	
				77-6201	14mm x 120mm bolt, pitch	2
					14mm nyloc nut	6
					14mm washer	8
					14mm x 100mm bolt, pitch	2
47	55-36-6200	1	Rear Crossmember	55-16-6200 - cam bolt	2	77-6201A
				55-15-6200 - cam washer	4	
				55-45-6200 - lockout plate	4	
				77-6201	14mm x 120mm bolt, pitch	2
					14mm nyloc nut	6
					14mm washer	8
					14mm x 100mm bolt, pitch	2
49	21-3205	1	5/16" ID vent hose	0.313" x 0.438" x 4"		77-6201B
	23-3205	1	hose adapter			
53	55-37-6200	1	Belly Pan	3/8" x 1" carriage bolt	4	77-6203
				3/8" flange nut	4	
60	55-22-6200	2	Strut Spacer	3/8" x 1" carriage bolt, coarse thread	3	77-40050
				3/8" flange nut	3	
				3/8" push nut	3	
65	55-46-6200	1	Driver Side Bumpstop Bracket	55-43-6200 - Tab Nut	1	77-6202A
				55-44-6200 - Tab Nut	1	
				3/8" x 1" bolt, coarse thread	2	77-6202
				3/8" SAE washer	2	
65	55-47-6200	1	Passenger Side Bumpstop Bracket	55-43-6200 - Tab Nut	1	77-6202A
				55-44-6200 - Tab Nut	1	
				3/8" x 1" bolt, coarse thread	2	77-6202
				3/8" SAE washer	2	
69	55-31-6200	1	Driver Side Knuckle	F470L threadlocker	1	77-6200
69	55-32-6200	1	Passenger Side Knuckle	F470L threadlocker	1	77-6200
77	55-33-6200	2	Front Brakeline Bracket	1/4" x 1" bolt, self-tapping	1	77-6202
82	55-38-6200	1	Driver Side Sway Bar Bracket	1/2" x 1-1/2" bolt, coarse thread	2	77-6202
				1/2" SAE washer	2	
				1/2" flanger nut	2	
82	55-39-6200	1	Passenger Side Sway Bar Bracket	1/2" x 1-1/2" bolt, coarse thread	2	77-6202
				1/2" SAE washer	2	
				1/2" flanger nut	2	



STEP	PART NUMBER	QTY. PER KIT	DESCRIPTION	NEW ATTACHING HARDWARE	QTY. PER BRACKET	HARDWARE BAG NUMBER
<b>REAR</b>						
13	01-044	2	Rear Lift Block	10482 - 9/16" x 2-1/2" x 11-1/2" ubolt	2	77-1509
				9/16" hi-nut	4	
				9/16" washer	4	
15	659583	1	Rear Shocks		2	77-6210 77-80038 x 2
17	55-34-6200	1	Rear Brakeline Bracket	8mm x 20mm bolt, pitch 1.25	2	77-6204
				8mm x 20mm flange nut	2	
19	55-11-6200	1	Emergency Brakeline Bracket	8mm x 20mm bolt, pitch 1.25	2	77-6204
				8mm flange nut	2	
				8mm flat washer	4	
21	55-10-5064	2	Rear Sway Bar Link	12mm x 70mm bolt, pitch	2	77-6204
				12mm nyloc nut	2	
				12mm washer	2	
				7/16" uss washer	2	
				01-60416 - 5/8" bushing	2	77-6204A
				021-5150 - Sleeve	2	

**KIT BOX BREAKDOWN**

Kit Part Number 6200			Kit Part Number 6203		
Part Number	Qty.	Part Description	Part Number	Qty.	Part Description
55-31-6200	1	Driver Side Knuckle	55-37-6200	1	Belly Pan
55-32-6200	1	Passenger Side Knuckle	77-6203	1	Hardware Bag
77-6200	1	Hardware Bag			
Kit Part Number 6201			Kit Part Number 6204		
Part Number	Qty.	Part Description	Part Number	Qty.	Part Description
55-35-6200	1	Front Crossmember	55-11-6200	1	Emergency Brakeline Bracket
55-36-6200	1	Rear Crossmember	55-34-6200	1	Rear Brakeline Bracket
77-6201	1	Hardware Bag	01-044	2	Rear Lift Block
77-6201A	1	Hardware Bag	55-10-5064	2	Rear Sway Bar Link
77-6201B	1	Hardware Bag	77-1509	1	Hardware Bag
			77-6204	1	Hardware Bag
			77-6204A	1	Hardware Bag
Kit Part Number 6202			Kit Part Number 659583		
Part Number	Qty.	Part Description	Part Number	Qty.	Part Description
55-46-6200	1	Driver Side Bumpstop Bracket	659583	1	Rear Shocks
55-38-6200	1	Driver Side Sway Bar Bracket	77-6210		Hardware Bag
55-33-6200	2	Front Brakeline Bracket			
55-47-6200	1	Passenger Side Bumpstop Bracket			
55-39-6200	1	Passenger Side Sway Bar Bracket			
55-22-6200	2	Strut Spacer			
77-40050	1	Hardware Bag			
77-6202	1	Hardware Bag			
77-6202A	1	Hardware Bag			

## FRONT INSTALLATION

Save all factory components and hardware for reuse, unless noted.

1. Disconnect the battery.
2. Chock rear tires and place transmission in neutral.
3. Raise the front of the vehicle with a jack and secure a jack stand beneath each frame rail. Ease the frame down onto the stands, place transmission in park for automatic transmissions and low gear for manual.
4. Remove the front tires and wheels.
5. [Illustration 1 & 2] Remove the skid plates from the vehicle. [12mm]

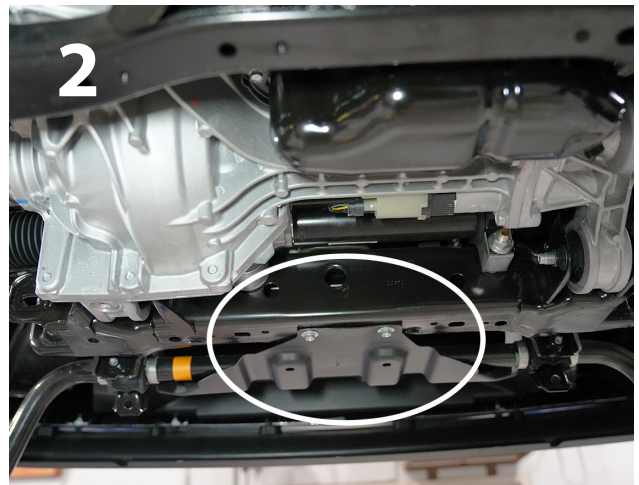

6. [Illustration 3] Remove the nut from the tie rod end. [22mm]
7. Disconnect the tie rod end from the knuckle.
8. [Illustration 4] Unbolt the sway bar link from the lower control arm. [17mm]

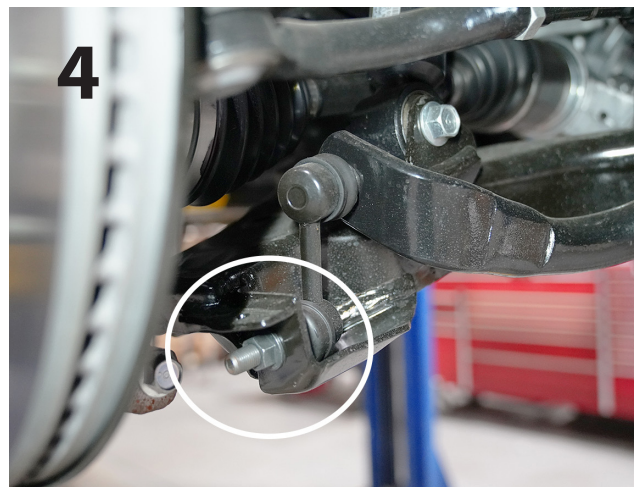

9. [Illustration 5] Mark the orientation of the sway bar body and hardware, then unbolt the sway bar body from the frame. [17mm]
10. [Illustration 6] Unbolt the brake line bracket from the knuckle. [13mm]



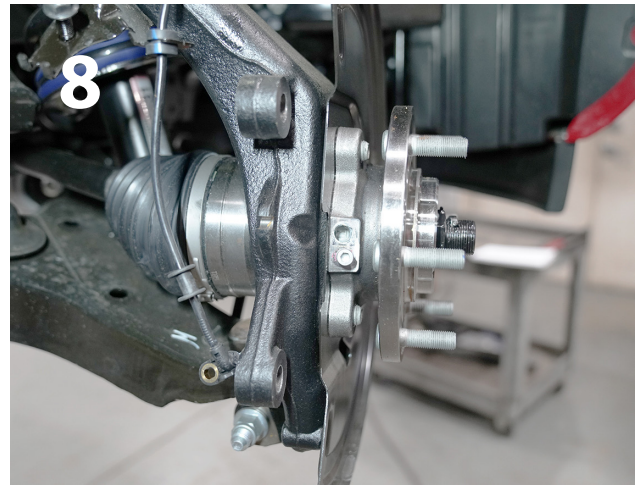
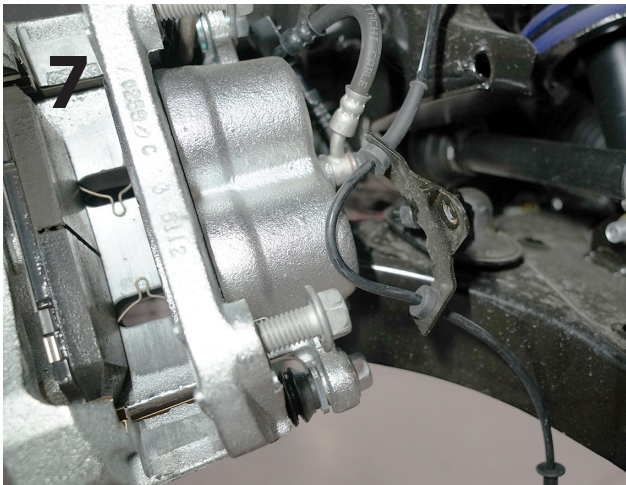

11. [Illustration 7] Unbolt the brake caliper and hang out of the way. DO NOT LET CALIPER HANG FROM THE BRAKE HOSES. [18mm]

12. Unclip the ABS wire from the knuckle.

13. [Illustration 8] Unbolt the ABS sensor from the knuckle. [5mm allen]

14. Remove the brake rotor.

15. [Illustration 9] Remove the axle nut. [32mm]

16. Unseat the axle from the hub, taking extreme caution to not damage the axle threads.

17. Loosen but do not remove the bolts securing the upper control arm to the frame.

18. [Illustration 10] Loosen but do not remove the nut from the upper ball joint. [22mm]

19. Carefully separate the upper ball joint from the knuckle.

20. Remove the upper ball joint nut and remove the upper control arm from the knuckle.





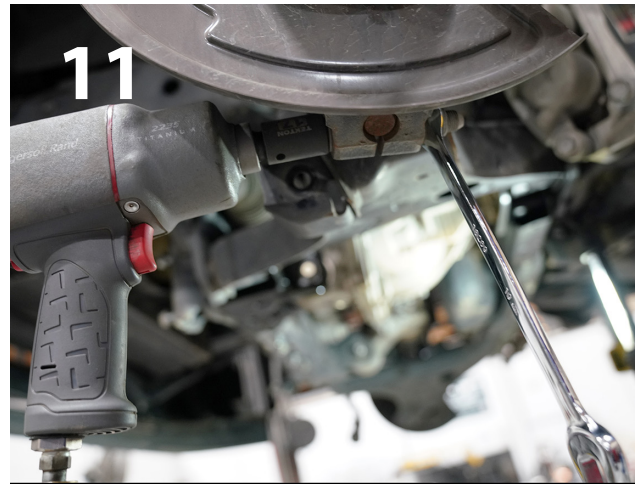

21. [Illustration 11] Remove the pinch bolt from the lower ball joint. [17mm, 19mm]

22. [Illustration 12] Carefully separate the lower ball joint from the knuckle, then remove the knuckle from the vehicle.

23. Secure the axle shaft up and out of the way.

24. Loosen but do not remove the bolts securing the lower control arm to the frame. [19mm, 22mm]

25. [Illustration 13] Remove the lower strut nuts from the bottom of the strut and allow the lower control arm to swing out of the way. [19mm]



26. Mark the outside orientation of the strut as well as driver and passenger.

27. [Illustration 14] Remove the upper strut nuts from the top of the strut and remove the strut from the vehicle. [14mm]

28. [Illustration 15] Remove the lower control arm from the vehicle. [19mm, 22mm]



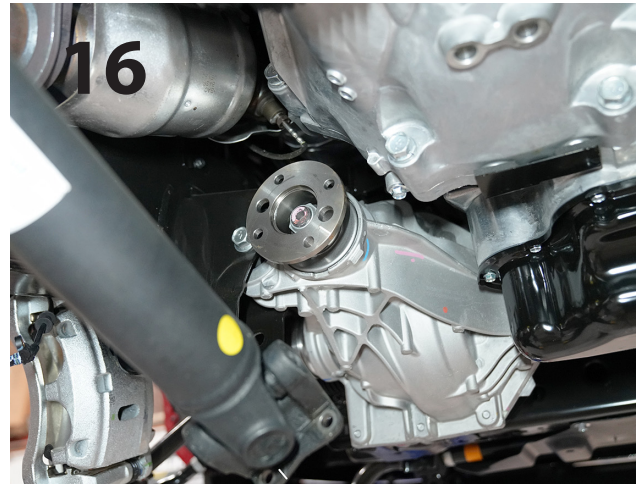

29. [Illustration 16] Mark the orientation of the driveshaft and remove the bolts. [14mm]
30. Secure the driveshaft up and out of the way.
31. [Illustration 17] Remove the rear crossmember support braces. [17mm]
32. [Illustration 18] Unbolt the rear crossmember, then remove the rear crossmember. [19mm]

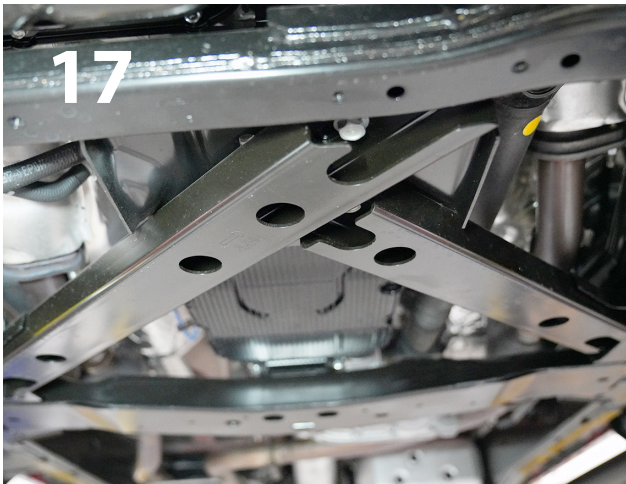

33. [Illustration 19] Disconnect the differential wiring harness and unbolt any brackets securing the wiring harness to the differential.

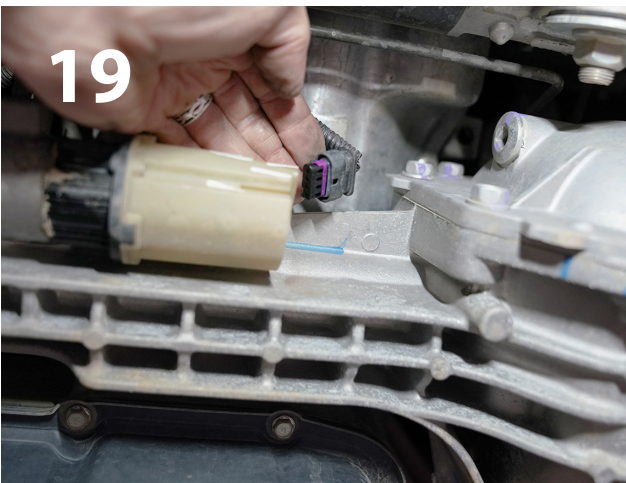



34. [Illustration 20] Disconnect the differential vent hose.

35. Support the differential using a jack or jack stands.



36. [Illustration 21] Remove the driver side rear bolt. [19mm]

37. [Illustration 22] Remove the driver side front bolt. [19mm]

38. [Illustration 23] Remove the passenger side bolt. [19mm]

39. [Illustration 24] Grind the tabs out of the inside of all four lower control arm mounts.

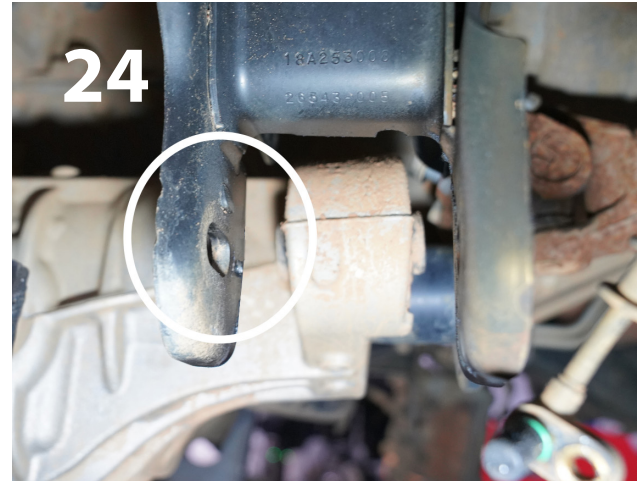

40. [Illustration 25] On both the front and rear of the driver rear lower control arm mount from the bottom edge measure from the inside to the outside and mark at 2.5".

41. [Illustration 25] Measure from the bottom edge to the top and mark at 4".

42. [Illustration 25] Mark lines along the measurements until the lines connect.

43. [Illustration 26] Using the appropriate cutting tool, cut along the lines.

44. [Illustration 26] Grind all the cut edges smooth and paint all exposed areas.



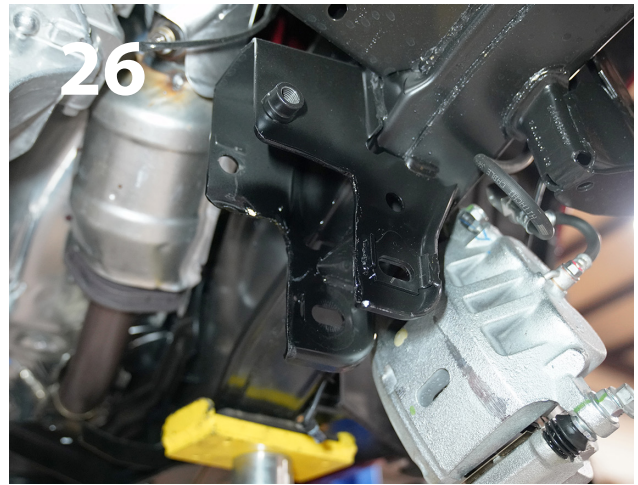
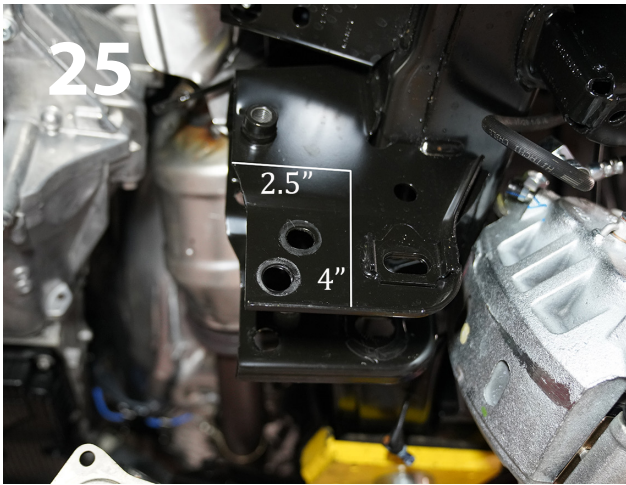

45. [Illustration 27] Install the new front crossmember (55-35-6200) and secure using the new lockout plates (55-45-6200) on both the front and rear of the control arm pocket with the supplied 14mm hardware with the bolts installing from the front; snug, do not tighten. [22mm]
46. [Illustration 28] Attach the front differential mounts to the front crossmember using the supplied 14mm hardware; do not tighten. [21mm]



47. [Illustration 29] Install the new rear crossmember (55-36-6200) into the frame and secure using the new lockout plates (55-45-6200) on both the front and rear of the control arm pocket with the supplied 14mm hardware with the bolts installing from the front; snug, do not tighten. [22mm]
48. [Illustration 29] Attach the differential to the rear crossmember using the supplied 14mm hardware. [22mm]
49. [Illustration 30] Install the new vent hose coupler (23-3205) and new vent hose (21-3205) to the factory vent hose.
50. Reconnect the differential wiring harness.
51. [Illustration 31] Install the lower control arm using the new cam bolts (55-16-6200 bolt, 55-15-6200 washer); do not tighten. [22mm]







52. [Illustration 32] Align the driveshaft with the previously made marks and reinstall using the factory hardware. [14mm]

53. [Illustration 31] Install the new belly pan (55-37-6200) between the front and rear crossmembers using the supplied 3/8" hardware; snug, do not tighten. [9/16"]

54. Tighten the front crossmember to the frame. [22mm] (115)

55. Tighten the rear crossmember to the frame. [22mm] (115)

56. Tighten the front and rear differential bolts. [22mm] (115)

57. Tighten the belly pan bolts. [9/16"] (35)

58. [Illustration 33] Unbolt the brake line block from the frame by removing the bolt located on the line by the upper control arm.

59. [Illustration 33] Using the appropriate cutting tool, cut the factory bracket open to free the brake line from the bracket. NOTE: Take extreme caution to not damage the brake line, any damage to the line will require it to be replaced.

60. [Illustration 34] Install the new strut spacer (55-22-6200) onto the top of the strut body and secure using the factory hardware. [14mm] (50)

61. [Illustration 34] Install the 3/8" carriage bolts into the strut spacer and place a push nut over the bolts to hold them in place while the strut is being installed.

62. [Illustration 35] Install the strut assembly into the vehicle and secure using the supplied 3/8" flange nuts; do not tighten. [9/16"]

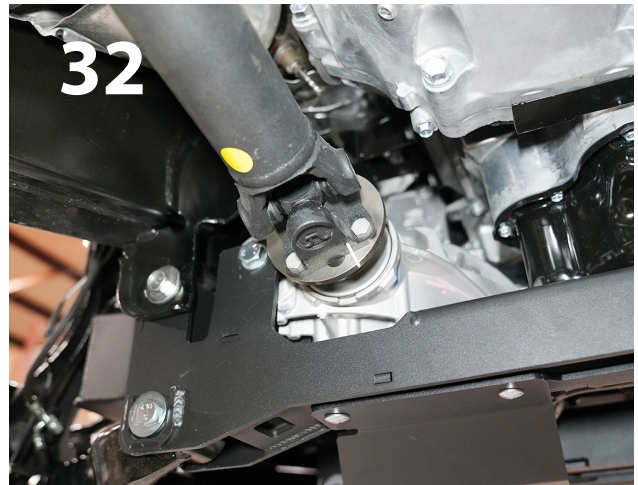



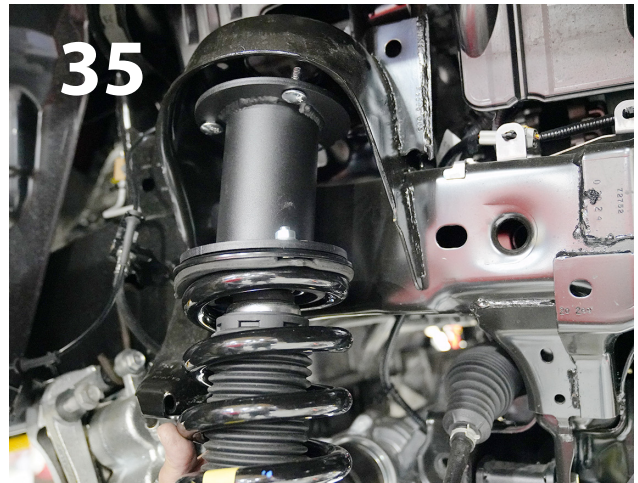
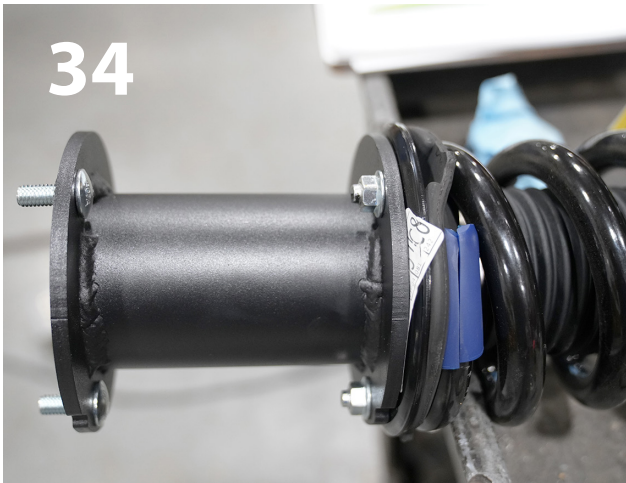

63. [Illustration 36] Swing the lower control arm up and attach to the strut assembly using the factory hardware; snug but do not tighten at this time. [19mm]

64. Tighten the upper strut bolts. [9/16"] (35)

65. [Illustration 37] Insert the "z" shaped tab nut (55-43-6200) through the hole on the out side of the frame above the bump stop bracket. Install the new bump stop extension (55-46-6200 driver, 55-47-6200 passenger) onto the frame and secure using the supplied 3/8" bolt through the bottom hole and fasten to the tab nut. [9/16"] (35)



66. [Illustration 38] Locate the upper hole on the new bump stop extension and using the bracket as a guide, drill a 3/8" hole into the frame.

67. Install the supplied 3/8" bolt and secure using the "u" shaped tab nut (55-44-6200) by installing the tab nut through the same frame opening as the previously installed tab nut. [9/16"] (35)

68. Remove the hub assembly and dust shield from the factory knuckle by removing the three bolts. [21mm]





69. Install the hub assembly and dust shield onto the new knuckle (66-31-6200 driver, 66-32-6200 passenger) using the factory hardware after applying the supplied thread locker to the threads. [21mm] (100)
70. [Illustration 39] Apply anti-seize to the CV axle spines, then install the knuckle onto the lower ball joint while sliding the axle into the hub and secure using the factory ball joint hardware. [17mm, 19mm] (130)
71. [Illustration 40] Attach the knuckle to the upper ball joint using the factory hardware. [22mm]



72. [Illustration 41] Install the CV axle nut. [32mm] (185)
73. [Illustration 41] Attach the ABS sensor to the knuckle. [5mm allen]
74. [Illustration 42] Install the brake rotor.
75. [Illustration 42] Install the brake caliper using the factory hardware; apply thread locker to the bolt threads. [18mm] (130)
76. [Illustration 43] Install the new brake line bracket (55-33-6200) to the frame using the supplied hardware. [7/16"]





77. Carefully reform the hard line to attach it to the new bracket using the factory horseshoe clip.
78. Attach the brake line bracket to the knuckle. [13mm]
79. Rotate the knuckle from lock to lock and check for clearance and make sure both the brake hose and ABS wire have plenty of slack; make adjustments as needed.
80. [Illustration 44] Remove the tie rod ends from the tie rods and swap sides putting the driver side tie rod end on the passenger side and vice versa.

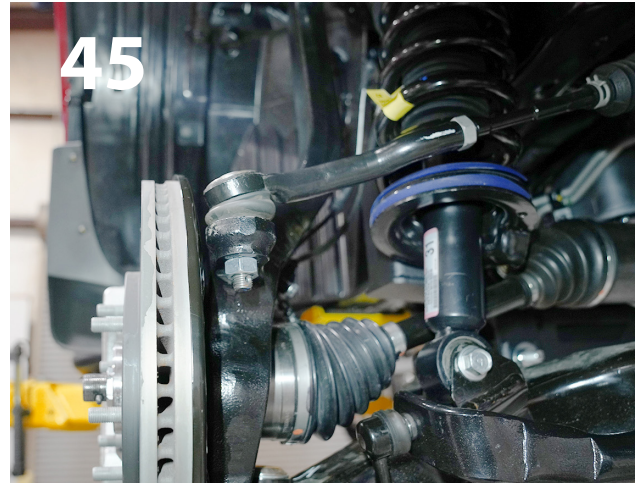

81. [Illustration 45] Attach the tie rod ends to the knuckles. [22mm] (45)
82. [Illustration 46] Install the new sway bar brackets (55-38-6200 driver, 55-39-6200 passenger) on the frame using the side specific factory hardware. [17mm] (55)



83. [Illustration 47] Attach the sway bar body to the new brackets using the supplied 1/2" hardware. [3/4] (75)
84. [Illustration 48] Attach the sway bar links to the lower control arm using the factory hardware. [17mm] (55)
85. Reinstall the front tires and wheels.

86. With the suspension 'hanging' at full extension travel, cycle the steering lock-to-lock and check all components for proper operation and clearances. Pay special attention to the clearance between the tires and wheels and knuckles, brake hoses, wiring, etc.

87. Lower the vehicle to the ground.

88. With the vehicle on the ground, cycle the steering lock-to-lock and check all components for proper operation and clearances. Pay special attention to the clearance between the tires and wheels and knuckles, brake hoses, wiring, etc. NOTE: Re-tighten lug nuts at 500 miles after any wheel change, or anytime the lug nuts are loosened. Failure to do so could cause wheels to come off while vehicle is in motion.

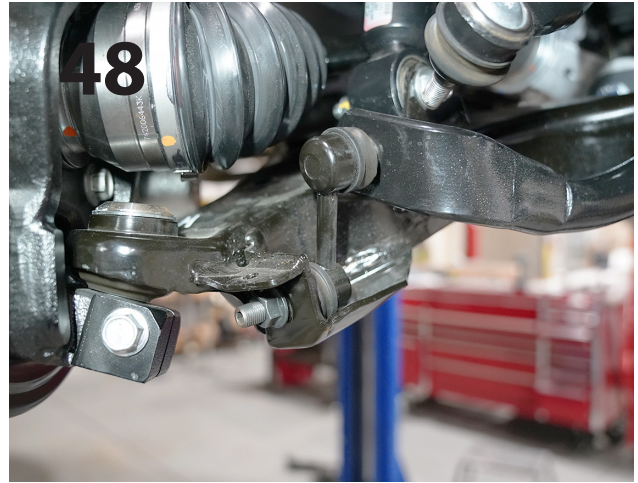

89. Tighten the lower strut bolt. [19mm] (50)

90. Tighten the upper control arm to frame bolts.

## REAR INSTALLATION

1. Disconnect the battery.

2. Chock front tires.

3. Raise the rear of the vehicle with a jack and secure a jack stand beneath each frame rail. Ease the frame down onto the stands.

4. Remove the rear tires and wheels.

5. Remove the shield over the brake hoses. [10mm]

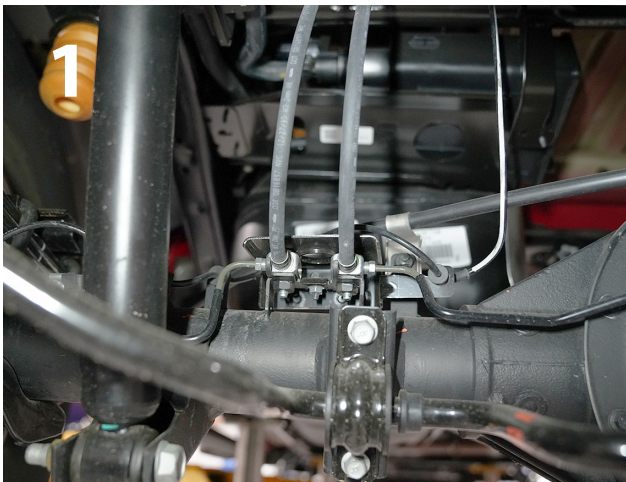



6. [Illustration 1] Unbolt the rear brake hose from the axle. [12mm]

7. [Illustration 2] Unbolt the rear emergency brake lines from the crossmember. [12mm]

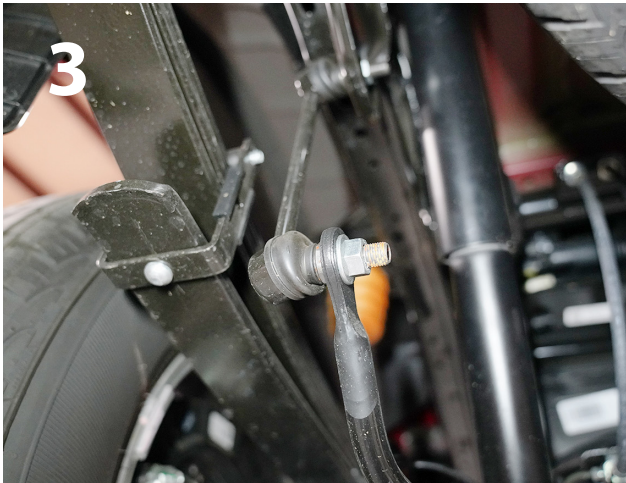

8. [Illustration 3] Remove the factory sway bar links. [19mm]

9. [Illustration 4] On the driver side at the upper shock mount there are four push pins to remove the plastic shield, then unclip the wiring harness from the frame to gain access to the upper shock bolt.

10. [Illustration 5] On the passenger side at the upper shock mount there are two push pins and two Philips head screws to be removed to remove the plastic shield, this will allow access to the upper shock bolt.

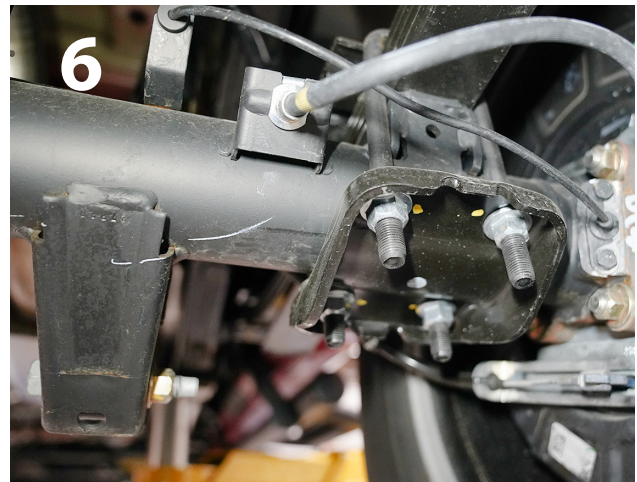

11. Support the rear axle and unbolt the shock absorbers from the frame and axle to remove from the vehicle. [19mm, 21mm]

12. [Illustration 6] Unbolt the ubolts from the axle. [19mm]

13. [Illustration 7] Lower the axle to install the new lift block (01-044).

14. [Illustration 7] Install the new ubolts (10482) and secure with the supplied 9/16" ubolt hardware. [7/8"] (90)



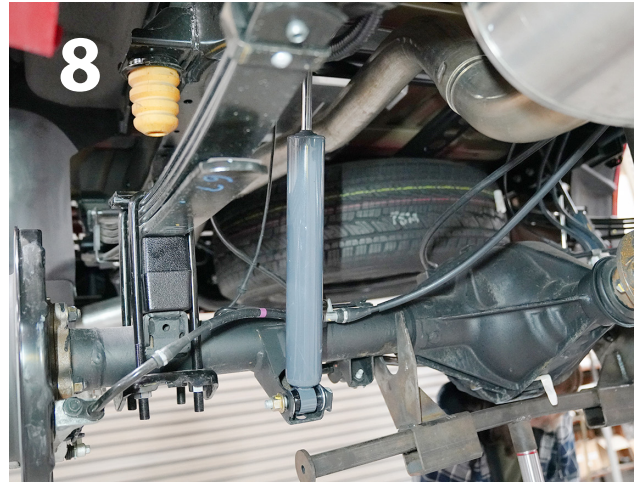
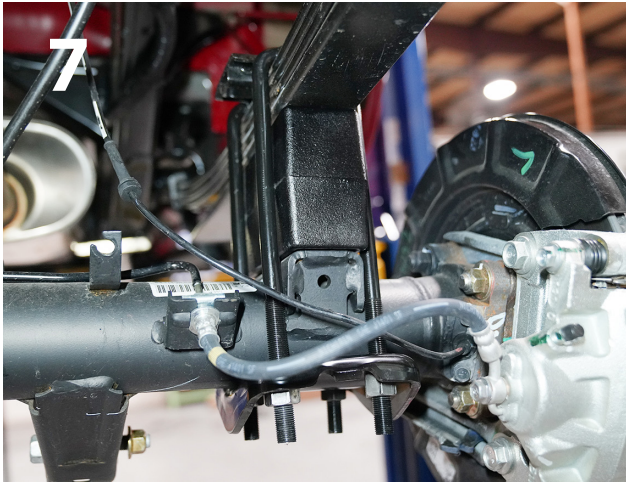

15. [Illustration 8] Install the supplied bushings and sleeves into the new shock absorbers (659583).

16. [Illustration 8] Install the new shock absorbers, secure using the factory hardware. [19mm, 21mm] (80)

17. [Illustration 9] Bolt the new brake line bracket (55-34-6200) to the axle with the short side to the axle and the flat side to the rear, using the supplied 8mm hardware. [13mm] (15)

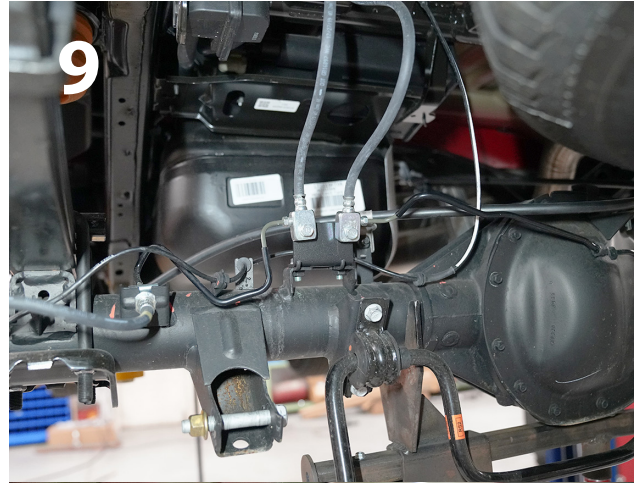

18. [Illustration 9] Carefully bend the brake lines to bolt the factory brake line bracket to the new bracket using the factory bolts and supplied nuts. [12mm, 13mm] (15)

19. [Illustration 10] Bolt the new emergency brake line bracket (55-11-6200) to the crossmember using the factory hardware. [12mm] (15)



20. [Illustration 10] Attach the cables to the new bracket using the supplied 8mm hardware. [13mm] (15)

21. [Illustration 11] Install the supplied bushings and sleeves into the new sway bar links (55-10-5064).

22. [Illustration 11] Attach the new sway bar links to the sway bar body

23. Install tire and wheels.

24. Remove jack stands and lower vehicle to the ground.

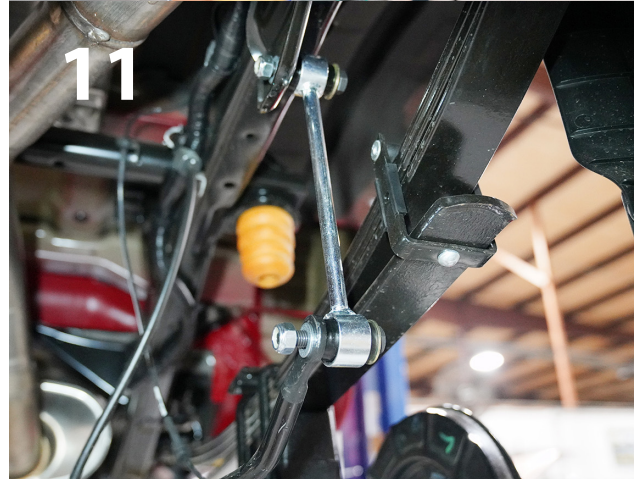



## FINAL CHECKS

1. Reconnect the battery.
2. Check all hardware for proper torque specifications.
3. With the vehicle on the ground, check all components for proper operation and clearances. Pay special attention to the clearance between the tires and wheels, brake hoses, wiring, etc.
4. Check tire and wheel clearance with the fenders and bumper as well as with the steering knuckle. Depending on your choice of tire size and wheel width, it is not uncommon to trim the lower plastic valance of the bumper and inner fender shroud slightly to add proper tire clearance while turning.
5. Align vehicle to factory specifications.
6. Adjust headlights to proper setting.
7. Activate the four wheel drive system and check for proper engagement.
8. Install the **WARNING TO DRIVER** decal on the inside of the windshield or sun visor, within driver's view.

### IMPORTANT MAINTENANCE INFORMATION

It is the ultimate buyer's responsibility to have all bolts / nuts checked for tightness after the first 100 miles and then every 1000 miles. The steering, suspension and driveline systems, plus wheel alignment should be inspected by a qualified professional mechanic at least every 3000 miles.

### LIMITED LIFETIME WARRANTY / WARNINGS

Your SUPERLIFT® product is covered by the Limited Warranty explained below that gives you specific legal rights. This limited warranty is the only warranty SUPERLIFT® makes in connection with your product purchase. SUPERLIFT® neither assumes nor authorizes any retailer or other person or entity to assume for it any other obligation or liability in connection with this product or limited warranty.

### SUPERLIFT, LLC, LIMITED LIFETIME WARRANTY

What is covered? Subject to the terms below, SUPERLIFT® will repair or replace its products found defective in materials or workmanship for so long as the original purchaser owns the vehicle on which the product was originally installed. Your warranter is SUPERLIFT, LLC, doing business as SUPERLIFT® Suspension Systems ("SUPERLIFT®").

What is not covered? Your SUPERLIFT® Limited Warranty does not cover products SUPERLIFT® determines to have been damaged by or subjected to:

- Alteration, modification or failure to maintain.
- Normal wear and tear (bushings, rod ends, etc.). Scratches or defects in product finishes (powder coating, plating, etc.).
- Damage to, or resulting from, the vehicle's electronic stability system, related components or other vehicle systems.
- Racing or other vehicle competitions or contests. Accidents, impact by rocks, trees, obstacles or other aspects of the environment.
- Theft, vandalism or other intentional damage.

Remedy Limited to Repair or Replacement. The exclusive remedy provided hereunder shall, upon SUPERLIFT's inspection and at SUPERLIFT's option, be either repair or replacement of the product covered under this Limited Warranty. Customers requesting warranty consideration should contact SUPERLIFT® by phone (1-800-551-4955) to obtain a Returned Goods Authorization number. All removal, shipping and installation costs are customer's responsibility.

If a replacement part is needed before the SUPERLIFT® part in question can be returned, you must first purchase the replacement part. Then, if the part in question is deemed warrantable, you will be credited / refunded.

#### **OTHER LIMITATIONS - EXCLUSION OF DAMAGES - YOUR RIGHTS UNDER STATE LAW**

- Neither SUPERLIFT® nor your independent SUPERLIFT® dealer are responsible for any time loss, rental costs, or for any incidental, consequential or other damages you may have.
- This Limited Warranty gives you specific rights, and this is the only warranty SUPERLIFT® makes in connection with your product purchase. You may also have other rights that vary from state to state. For example, while all implied warranties are disclaimed herein, any implied warranty required by law is limited to the terms of our Limited Lifetime Warranty as described above. Some states do not allow limitations of how long an implied warranty lasts and / or do not allow the exclusion or limitation of incidental or consequential damages, so the limitations and exclusions herein may not apply to you. SUPERLIFT® neither assumes nor authorizes any retailer or other person or entity to assume for it any other obligation or liability in connection with this product or Limited Warranty.

#### **IMPORTANT PRODUCT USE AND SAFETY INFORMATION / WARNINGS**

As a general rule, the taller a vehicle is, the easier it will roll over. Offset, as much as possible, what is lost in rollover resistance by increasing tire track width. In other words, go "wide" as you go "tall"; always use as wide a tire and wheel combination as feasible to enhance vehicle stability. We strongly recommend, because of rollover possibility, that the vehicle be equipped with a functional roll bar and cage system. Seat belts and shoulder harnesses should be worn at all times. Avoid situations where a side rollover may occur.

Generally, braking performance and capabilities are decreased when significantly larger / heavier tires and wheels are used. Take this into consideration while driving. Also, changing axle gear ratios or using tires that are taller or shorter than factory height will cause an erroneous speedometer reading. On vehicles equipped with an electronic speedometer, the speed signal impacts other important functions as well. Speedometer recalibration for both mechanical and electronic types is highly recommended.

Do not add, alter, or fabricate any factory or aftermarket parts to increase vehicle height over the intended height of the SUPERLIFT® product purchased. Mixing component brands is not recommended.

#### **THANKS FOR CHOOSING SUPERLIFT.**

For questions, technical support and warranty issues relating to this SUPERLIFT products, please contact SUPERLIFT directly.

**SUPERLIFT SUSPENSION**  
**300 Huey Lenard Loop Rd.**  
**West Monroe, Louisiana 71292**  
**Phone: (318) 397-3000**  
**Sales / Tech: (800) 551-4955**  
**Fax: (318) 397-3040**  
**SUPERLIFT.COM**