



300 HUEY LENARD LOOP | WEST MONROE | LA 71292  
 OFFICE: 318-397-3000 | FAX: 318-397-3040  
 SERVICE & TECH SUPPORT: 800-551-4955  
 SUPERLIFT.COM



## 2015-2019 FORD F-150 PICKUP 4WD 4.5 & 6 Inch Lift Kits INSTALLATION INSTRUCTIONS

Engineered for 4WD Models ONLY.

Fits: 2015-2019 Ford F-150 4WD

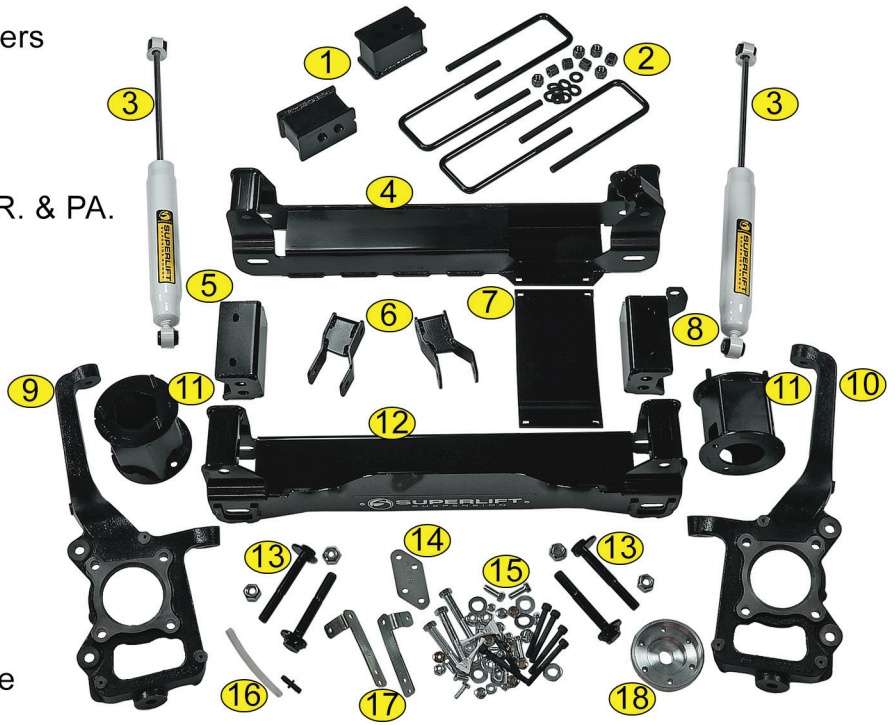


**CAUTION:** MAKE SURE YOU HAVE THE CORRECT LIFT FOR YOUR VEHICLE:  
 Double check the Year, Make, Model, Lift Height and KIT Part Numbers.

**NOTE:** Prior to beginning the installation, OPEN the Boxes and CHECK the Included Components Compared to the Parts Breakdown. Check all parts and hardware in the box with the parts list below. Be sure you have all needed parts and know where they install.

IF you find a packaging error, contact SUPERLIFT directly. Do not contact the dealer where the system was originally purchased. You will need the control number from each box when calling; this number is located at the bottom of the part number label and to the right of the bar code.

- 1 Lift Block, Rear
- 2 9/16" U-Bolts, U-Bolt Nuts & Washers
- 3 Shock Absorbers, Rear
- 4 Crossmember, Rear
- 5 Sway Bar Drop Bracket, PA. Side
- 6 Differential Drop Bracket, Front, DR. & PA.
- 7 Belly Pan
- 8 Sway Bar Drop Bracket, DR. Side
- 9 Knuckle, PA. Side
- 10 Knuckle, DR. Side
- 11 Strut Spacer, Front
- 12 Crossmember, Front
- 13 Eccentric Cam Bolts
- 14 Brake Line Bracket, Rear
- 15 Hardware & Thread Locker
- 16 Vacuum Hose & Adapter
- 17 Brake Line Bracket, DR. & PA. Side
- 18 Driveshaft Spacer, Front





300 HUEY LENARD LOOP | WEST MONROE | LA 71292  
 OFFICE: 318-397-3000 | FAX: 318-397-3040  
 SERVICE & TECH SUPPORT: 800-551-4955  
 SUPERLIFT.COM



## 2015-2019 FORD F-150 PICKUP 4WD 4.5 & 6 Inch Lift Kits INSTALLATION INSTRUCTIONS

**THANK YOU FOR CHOOSING  
 SUPERLIFT FOR ALL YOUR  
 SUSPENSION NEEDS!**

**Read And Understand All Instructions And Warnings Prior To Installation Of System  
 AND Operation Of Vehicle.**

### **INTRODUCTION BEFORE INSTALLATION...**

Installation requires a professional mechanic. In addition to these instructions, professional knowledge of disassembly / reassembly procedures and post installation checks must be known.

PRIOR to beginning, inspect the vehicles steering, driveline, and brake systems, paying close attention to the suspension link arms and bushings, sway bars and bushings, tie rod ends, pitman arm, idler arm, ball joints and wheel bearings. Also check the steering sector-to-frame and all suspension-to-frame attaching points for stress cracks. The overall vehicle must be in excellent working condition; repair or replace all worn parts.

Read instructions several times before starting.

Read each step completely as you go.

**Be sure you have all needed parts and know where they install.**

### **⚠ NOTES:**

- Do NOT install this suspension system in conjunction with any other type of torsion bar lift keys than those included in the kit nor heavy-duty replacement torsion bars.
- Front end alignment is necessary.
- A foot-pound torque reading is given in parenthesis ( ) after each appropriate fastener.
- Tool and Wrench/Socket size is given in brackets [ ] after each appropriate step.
- Always wear safety glasses when using power tools.
- Prior to attaching components, be sure all mating surfaces are free of grit, grease, excessive undercoating, etc.
- Do not fabricate any components to gain additional suspension height.
- A factory service manual should be on hand for reference.
- Due to payload options and initial ride height variances, the amount of lift is a 'base figure'. Final ride height dimensions may vary in accordance to original vehicle stance.
- Vehicles equipped with a two-piece rear driveshaft Will Need to Order an additional kit box #9935 for the carrier bearing shims.

### **BEFORE YOU DRIVE...**

Check all fasteners for proper torque. Check to ensure for adequate clearance between all rotating, mobile, fixed, and heated members. Verify clearance between exhaust and brake lines, fuel lines, fuel tank, floor boards and wiring harness. Check steering components for clearance.

Test and inspect brake system. Perform steering sweep to ensure front brake hoses have adequate slack and do not contact any rotating, mobile or heated members. Inspect rear brake hoses at full extension for adequate slack. Failure to perform hose check/replacement may result in component failure.

Perform head light check and adjustment.

**TIRES & WHEELS...**

Larger rim and tire combinations may increase leverage on suspension, steering, and related components. When selecting combinations larger than OE, consider the additional stress you could be inducing on the OE and related components.

**TECH TIP / TIME SAVER...**

- Some minor trimming will be required with certain wheel/ tire combination. This is normal with most aftermarket tire/wheel fitments on Ford F-150 trucks. Trimming will normally include the bottom edge of the inner fender shrouds and/or lower corner of front bumper valance. As a rule of thumb, deeper backspacing and shorter/ narrower tires will reduce/eliminate trimming required.

**TIRES & WHEELS...**

Larger rim and tire combinations may increase leverage on suspension, steering, and related components. When selecting combinations larger than OE, consider the additional stress you could be inducing on the OE and related components.

**NOTE:** Stock 18" Wheels Will Fit back on the vehicle once this suspension system is installed.

**WARNING:** ANY larger or wider tire & wheel combination other than listed Will Require Vehicle Trimming.

**NOTE:** ALL Tire & Wheel Combinations Should Be Test Fit Prior to Installation.

**IMPORTANT DISCLAIMER:** The provided tire/wheel fitments are approximate. Actual dimensions of a given tire size can vary considerably from one brand to another. Manufacturers' wheel offset and backspacing measurement points are not always consistent. Backspacing greatly impacts tire-to-fender clearance when turning. Wheel width and backspacing influence whether the tires protrude past the fenders, and to what extent. Considering these important factors, we recommend that you fit-check your tire/wheel selection prior to purchasing.

**NOTE:** Depending on the tire and wheel combination, there may be a need to trim the front crash bar and lower valance / air dam.

**TOOLS & TECH...**

This is a list of tools needed to install this lift kit. Double check the list to make sure that you have all the tools and equipment required to accomplish the complete install.

4.5 Inch Lift			
RECOMMENDED TIRE SIZE SPECIFICATIONS			
Tire	Wheel	Backspacing (IN)	Offset (MM)
33 x 12.5	18 x 9	4.5	-
35 x 12.5	18 x 9	5.3	19
33 x 12.5	20 x 9	4.5	-
35 x 12.5	20 x 9	5.3	25

6 Inch Lift			
RECOMMENDED TIRE SIZE SPECIFICATIONS			
Tire	Wheel	Backspacing (IN)	Offset (MM)
35 x 12.5	18 x 9	5.3	19
35 x 13.5	18 x 9	5	13
35 x 13.5	18 x 9	4.5	-
35 x 12.5	20 x 9	5.5	25
35 x 13.5	20 x 9	5	13
35 x 13.5	20 x 9	4.5	-
35 x 12.5	20 x 10	4.3	-19

Tools		
Miscellaneous Tools	Wrench / Socket Sizes	
	Standard	Metric
Floor Jack		
Jack Stands	3/8"	8mm
Flathead Screwdriver	7/16"	10mm
Hammer	1/2"	13mm
Plastic Fastener Removal Tool	9/16"	15mm
Die Grinder With Cut-Off Wheel	5/8"	18mm
Torque Wrench	3/4"	19mm
Drill	13/16"	21mm
Drill Bits - 7/32", 9/32", & 11/32"	7/8"	27mm
Pry Bar		8mm Allen
Ball-Peen Hammer		5mm Allen
Chisel		

**How to Read the Kit Breakdown Charts:** The 'K KIT BREAKDOWN' lists the Part Numbers, Quantities & Part Description of the Boxes that are included in the K KIT. The 'KIT BREAKDOWN' lists Part Numbers, Quantities & Part Description of the Individual Components & Hardware Bags that are included in Each Box. The 'HARDWARE BREAKDOWN' lists the Part Numbers, Quantities & Part Description of the Individual Components.

K KIT BREAKDOWN					
Kit Part Number K102 4.5" Lift Kit			Kit Part Number K103 6" Lift Kit		
Part Number	Qty.	Part Description	Part Number	Qty.	Part Description
9930	1	Kit Box, Knuckles	9930	1	Kit Box, Knuckles
9931	1	Kit Box, Crossmember, Belly Pan & Sway Bar Drop	9931	1	Kit Box, Crossmember, Belly Pan & Sway Bar Drop
9932	1	Kit Box, Differential, Bump Stops, Driveshaft Spacer & SUPERLIFT Shocks	9932	1	Kit Box, Differential, Bump Stops, Driveshaft Spacer & SUPERLIFT Shocks
9934	1	Kit Box, Strut Spacer	9933	1	Kit Box, Strut Spacer
OR			OR		
Kit Part Number K102B 4.5" Lift Kit			Kit Part Number K103B 6" Lift Kit		
Part Number	Qty.	Part Description	Part Number	Qty.	Part Description
9930	1	Kit Box, Knuckles	9930	1	Kit Box, Knuckles
9931	1	Kit Box, Crossmember, Belly Pan & Sway Bar Drop	9931	1	Kit Box, Crossmember, Belly Pan & Sway Bar Drop
9932B	1	Kit Box, Differential, Bump Stops, Driveshaft Spacer & BILSTEIN Shocks	9932B	1	Kit Box, Differential, Bump Stops, Driveshaft Spacer & BILSTEIN Shocks
9934	1	Kit Box, Strut Spacer	9933	1	Kit Box, Strut Spacer

KIT BREAKDOWN					
Kit Part Number 9930			Kit Part Number 9932B		
Part Number	Qty.	Part Description	Part Number	Qty.	Part Description
66-01-9930	1	Knuckle, Driver	55-03-9930	1	Differential Drop, Driver
66-02-9930	1	Knuckle, Passenger	55-04-9930	1	Differential Drop, Passenger
			55-12-9930	2	Bump Stop, Rear
Kit Part Number 9931			55-30-9930	2	Block, Rear
Part Number	Qty.	Part Description	66-11-9910	1	Driveshaft Spacer, Front
55-05-9930	1	Crossmember, Front	77-9930	1	Hardware Bag, SUPERLIFT parts
55-06-9930	1	Crossmember, Rear	77-9932	1	Hardware Bag, Nuts and Bolts
55-07-9930	1	Sway Bar Drop, Driver	BE5-6249-H5	2	BILSTEIN Shock Cylinder, Rear
55-08-9930	1	Sway Bar Drop, Passenger			
55-10-9930	1	Belly Pan	Kit Part Number 9933 6" Lift Kit		
77-9931	1	hardware bag, cam bolts	Part Number	Qty.	Part Description
			10352	4	9/16" x 3-5/16" x 11" Ubolts, Square
Kit Part Number 9932			55-09-9930	2	Strut Spacers (6")
Part Number	Qty.	Part Description	77-1509	1	Ubolt Nuts and Washers
55-03-9930	1	Differential Drop, Driver	Kit Part Number 9934 4.5" Lift Kit		
55-04-9930	1	Differential Drop, Passenger	Part Number	Qty.	Part Description
55-12-9930	2	Bump Stop, Rear	10342	4	9/16" x 3-5/16" x 10" Ubolts, Square
55-30-9930	2	Block, Rear	55-11-9930	2	Strut Spacers (4.5")
66-11-9910	1	Driveshaft Spacer, Front	77-1509	1	Ubolt Nuts and Washers
77-9930	1	Hardware Bag, SUPERLIFT parts			
77-9932	1	Hardware Bag, Nuts and Bolts			
01-85150	2	SUPERLIFT Shock Cylinder, Rear			

HARDWARE BREAKDOWN					
Kit Part Number 77-9930			Kit Part Number 77-9932		
Part Number	Qty.	Part Description	Part Number	Qty.	Part Description
01-60418	4	01-60418, Hourglass Bushing	10MFN	6	10mm Flange Nut
21-3205	1	5/16" x 3-1/2" Vacuum Hose	10MFW	2	10mm Flat Washer
23-3205	1	5/16" Hose Adapter	10MX1.5X150CS	2	10mm x 1.5 x 150mm Bolt
24-5704	4	24-5704, 0.75" OD x 0.50" ID x 1.54" L, Sleeve	10MX1.5X90SHB	6	10mm x 1.5 x 90mm Bolt, Socket Head
55-16-9910	1	Brake Line Bracket, Rear	14X12STB	2	1/4" x 1/2" Bolt, Self-Tapping
55-18-9910	1	Brake Line Bracket, Front Passenger	18MFW	8	18mm Flat Washer
55-19-9910	1	Brake Line Bracket, Front Driver	18MLN	6	18mm Stover Nut
			18MX2.5X150CS	2	18mm x 2.5 x 150mm Bolt
			38C5FN	4	3/8" Flange Nut
Kit Part Number 77-9931			38X1C5CB	4	3/8" x 1" Carriage Bolt, Coarse Thread
Part Number	Qty.	Part Description	516C5NN	2	5/16" Nyloc Nut
55-20-9930	4	Cam Bolt	516C8SN	1	5/16" Stover Nut
			516SW	3	5/16" SAE Washer
Kit Part Number 77-1509			516X1C5CS	1	5/16" x 1" Bolt, Coarse Thread
Part Number	Qty.	Part Description	516X1STB	1	5/16" x 1" Bolt, Self-Tapping
1511-B09	8	9/16" High Nut, Fine Thread	516X34C5CS	2	5/16" x 3/4" Bolt, Coarse Thread
1509	8	9/16" Ubold Washer	716C8SN	4	7/16" Stover Nut
			716SW	4	7/16" SAE Washer
			716X1C5CS	4	7/16" x 1" Bolt, Coarse Thread
			916C8SN	3	9/16" Stover Nut
			916SW	3	9/16" SAE Washer
			916X334C5CS	3	9/16" x 3-3/4" Bolt, Coarse Thread
			F470L	2	F470L, Thread Locker



Step	Part Number	Qty. per Kit	Description	New Attaching Hardware	Qty. per Bracket	Hardware Bag Number
21	55-03-9930	1	Differential Drop, Driver	9/16" x 3-3/4" Bolt, Coarse Thread	1	77-9932
				9/16" SAE Washer	1	
				9/16" Stover Nut	1	
21	55-04-9930	1	Differential Drop, Passenger	9/16" x 3-3/4" Bolt, Coarse Thread	1	77-9932
				9/16" SAE Washer	1	
				9/16" Stover Nut	1	
21	21-3205	1	5/16" x 3-1/2" Vacuum Hose			77-9930
21	23-3205	1	5/16" Hose Adapter			
22	55-07-9922	1	Sway Bar Drop, Driver	7/16" x 1" Bolt, Coarse Thread	2	77-9932
				7/16" SAE Washer	2	
				7/16" Stover Nut	2	
22	55-08-9922	1	Sway Bar Drop, Passenger	7/16" x 1" Bolt, Coarse Thread	2	77-9932
				7/16" SAE Washer	2	
				7/16" Stover Nut	2	
23	55-06-9922	1	Crossmember, Rear	9/16" x 3-3/4" Bolt, Coarse Thread	1	77-9932
				9/16" SAE Washer	1	
				9/16" Stover Nut	1	
				18mm Stover Nut	4	
				18mm Flat Washer	6	
				18mm x 2.5 x 150mm, Bolt	2	
55-20-9930, Cam Bolt (Long)	2	77-9923				
25	55-05-9922	1	Crossmember, Front	55-20-9922, Cam Bolt (Short)	2	77-9923
				18mm Stover Nut	2	77-9932
				18mm Flat Washer	2	
28	55-10-9922	1	Belly Pan	3/8" x 1" Carriage Bolt, Coarse Thread	4	77-9932
				3/8" Flange Nut	4	
29	66-11-9910	1	Driveshaft Spacer, Front	10mm x 1.5 x 90mm Bolt, Socket Head	6	77-9932
				F470L, Thread Locker	1	
31	55-09-9930	2	Strut Spacer (6")	10mm Flange Nut	3	77-9932
<b>OR</b>						
31	55-11-9930	2	Strut Spacer (4.5")	10mm Flange Nut	3	77-9932
33	66-01-9930	1	Knuckle, Driver	F470L, Thread Locker	0.5	77-9932
33	66-02-9930	1	Knuckle, Passenger	F470L, thread locker	0.5	77-9932
41	55-19-9910	1	Brake Line Bracket, Front Driver	5/16" x 3/4" Bolt, Coarse Thread	1	77-9932
				5/16" Nyloc Nut	1	
				5/16" SAE Washer	1	
				1/4" x 1/2" Bolt, Self-Tapping	1	
41	55-18-9910	1	Brake Line Bracket, Front Passenger	5/16" x 3/4" Bolt, Coarse Thread	1	77-9932
				5/16" Nyloc Nut	1	
				5/16" SAE Washer	1	
				1/4" x 1/2" Bolt, Self-Tapping	1	
54	55-31-9930	2	Block, Rear (6")	9/16" x 3-5/16" x 11" Ubolt, Square	4	77-1509
				9/16" High Nut, Fine Thread	8	
				9/16" Ubolt Washer	8	
<b>OR</b>						
54	55-30-9930	2	Block, Rear (4.5")	9/16" x 3-5/16" x 10" Ubolt, Square	4	77-1509
				9/16" High Nut, Fine Thread	8	
				9/16" Ubolt Washer	8	
55	55-16-9910	1	Brake Line Bracket, Rear	5/16" x 1" Bolt, Coarse Thread	1	77-9932
				5/16" Stover Nut	1	
				5/16" SAE Washer	1	
				5/16" x 1" Bolt, Self-Tapping	1	
58	01-85150	2	SUPERLIFT Shock Cylinder, Rear	01-60418, Hourglass Bushing	2	77-9930
				24-5704, 0.75" OD x 0.50" ID x 1.54" L, sleeve	2	
<b>OR</b>						
58	BE5-6249-H5	2	BILSTEIN Shock Cylinder, Rear	01-60418, Hourglass Bushing	2	77-9930
				24-5704, 0.75" OD x 0.50" ID x 1.54" L, sleeve	2	
59	55-12-9930	2	Bump Stop, Rear	10mm x 1.5 x 150mm, Socket Bolt	1	77-9932
				10mm Flat Washer	1	

**NOTE:** Use the check-off box  found at each step to help you keep your place. Two  denotes that one check-off box is for the Driver Side (Left) and one is for the Passenger Side (Right). Unless otherwise noted, always start with the Driver Side.

## FRONT DISASSEMBLY

**NOTE:** Save all factory components and hardware for reuse, unless noted.

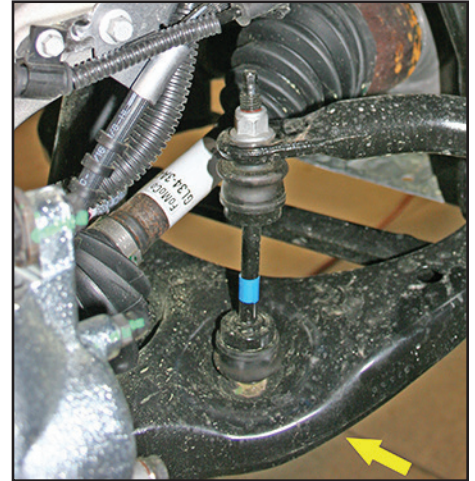
### 1) PREPARE VEHICLE...

Chock rear tires and place transmission in neutral. Raise front of vehicle with a jack and secure a jack stand beneath each frame rail. Ease the frame down onto the stands and place transmission in park. Remove front tires. [Lug Nuts 21mm]

### 2) SWAY BAR LINKS...

[Illustration 1] Disconnect the lower end of the sway bar links from the lower control arm. [18mm]

Illustration 1

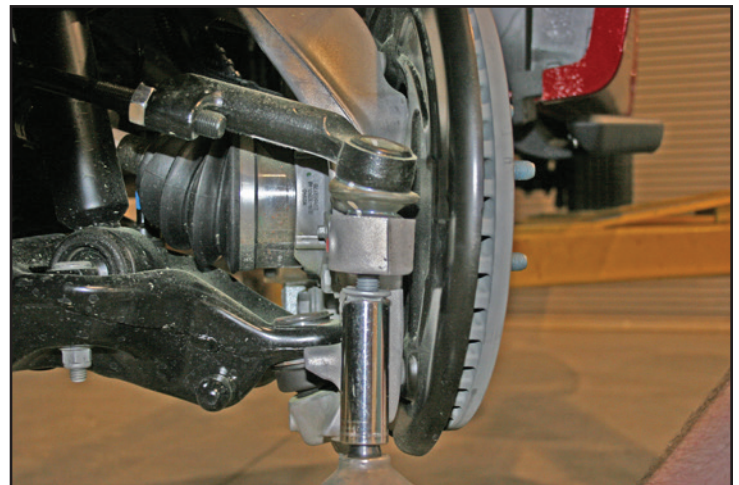


Perform steps 3 through 14 one side at a time.

### 3) STEERING TIE ROD END...

[Illustration 2] Remove the nut from the tie rod end and using the appropriate puller tool remove tie rod from knuckle. If you do not have a puller tool you can use a hammer by very carefully striking the tie rod boss of the knuckle; do not strike the tie rod end. [21mm]

Illustration 2



### 4) BRAKE LINE BRACKET AND ABS SENSOR WIRE...

[Illustration 3] Unclip the vacuum lines from the brake line bracket. [plastic fastener removal tool]

[Illustration 4] Locate the brake line bracket on the steering knuckle and remove. [10mm]

[Illustration 4] Remove the ABS sensor wire from the steering knuckle. [8mm]

Illustration 3

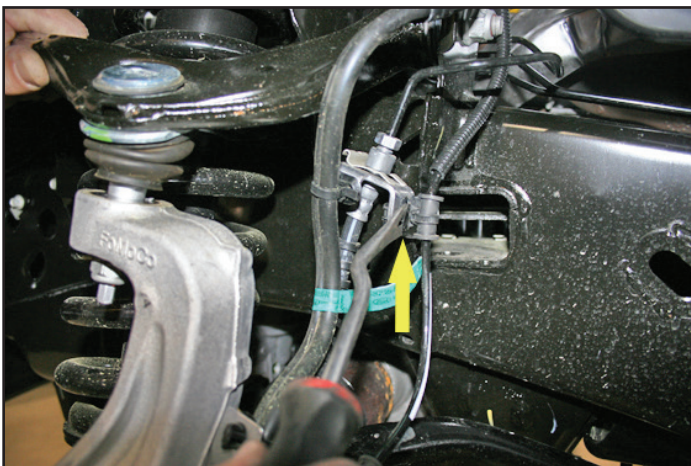
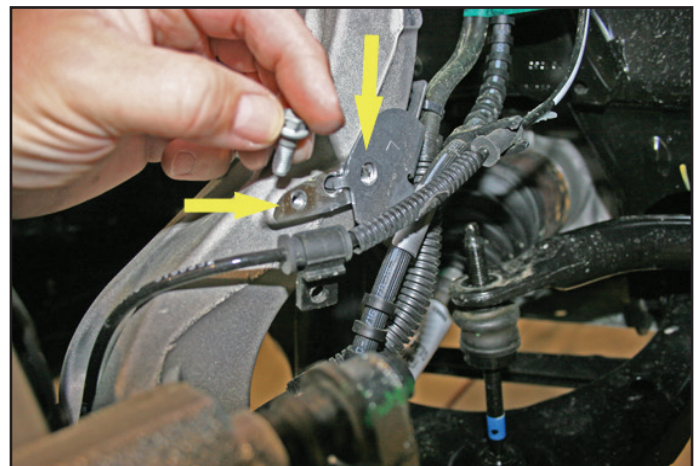


Illustration 4





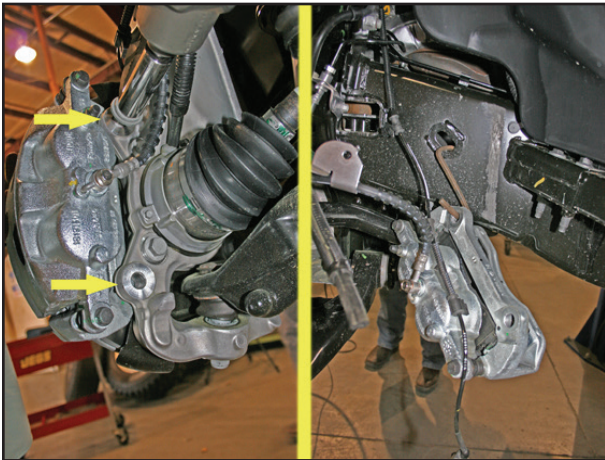
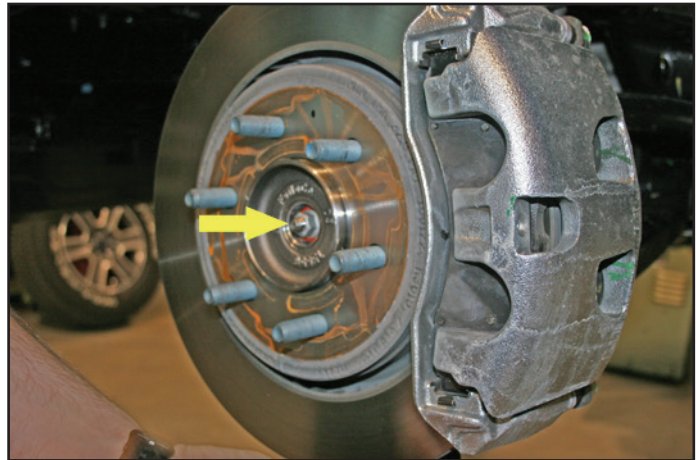
**5) BRAKE CALIPER...**

[Illustration 5] Unbolt the brake caliper and remove from the rotor and secure it away from the work area. **NOTE:** Do not let calipers hang from brake lines. [21mm]

Remove the front rotor from the hub.

**6) CV SHAFT NUT...**

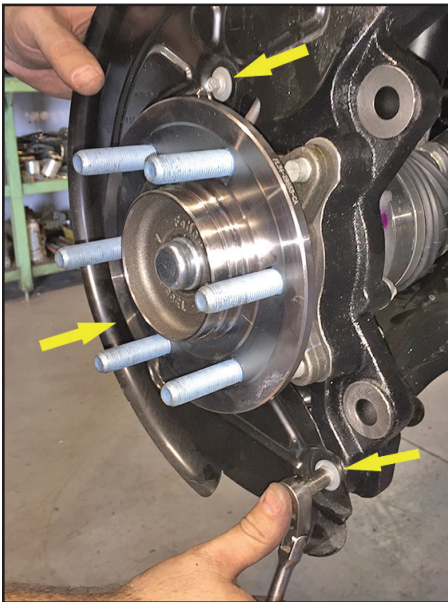
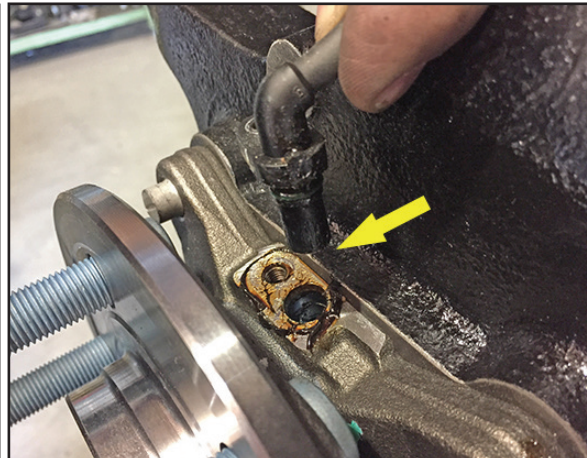
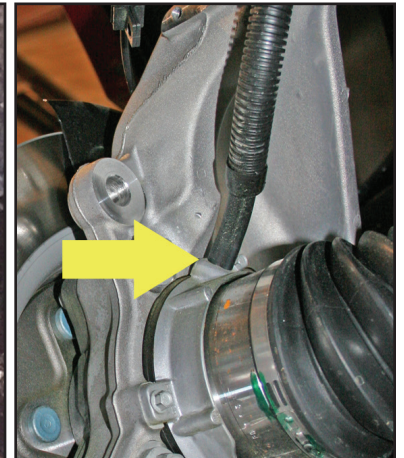
[Illustration 6] Remove the CV shaft dust cap from the outside of the hub assembly. Remove the retaining nut from the CV shaft. [flathead screwdriver, hammer, 15mm or 13mm]

**Illustration 5****Illustration 6****7) DUST SHIELD...**

[Illustration 7] Remove the three bolts holding the dust shield on the knuckle. [8mm]

**8) ABS SENSOR AND VACUUM LINES...**

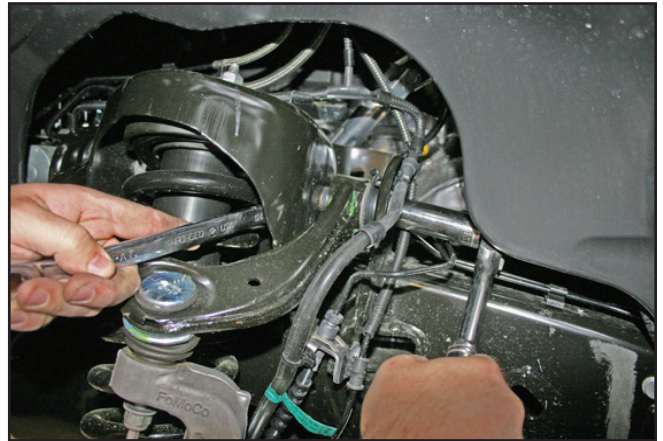
[Illustrations 8 & 9] Remove the ABS sensors from the top of the hub assembly, and vacuum lines from the vacuum module. [5mm allen, plastic fastener removal tool]

**Illustration 7****Illustration 8****Illustration 9**

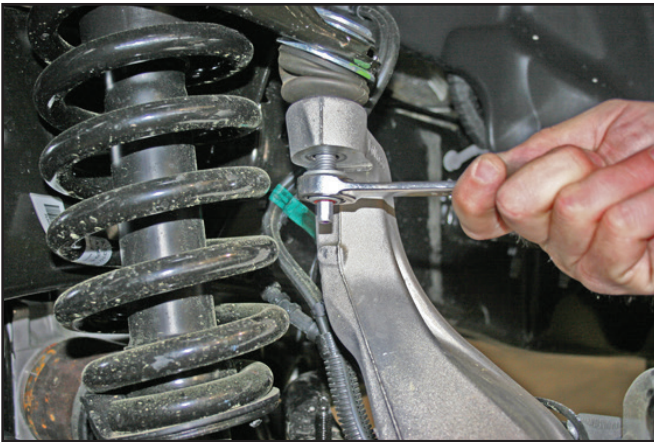
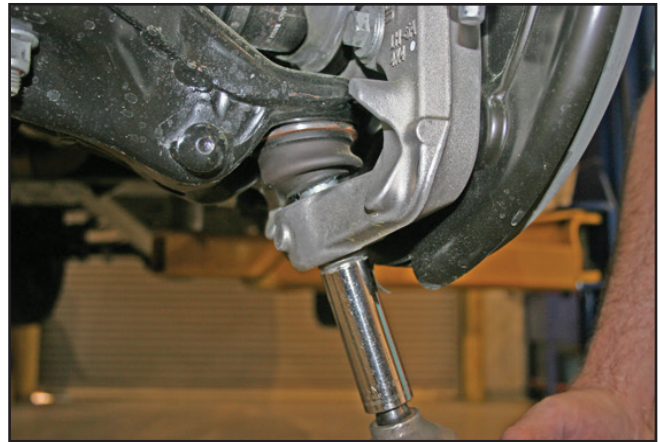


**9) UPPER CONTROL ARM...**

[Illustration 10] Loosen, but do not remove, the four upper control arm bolts (2 per side). [bolt 18mm, nut 21mm]

**Illustration 10****10) KNUCKLE...**

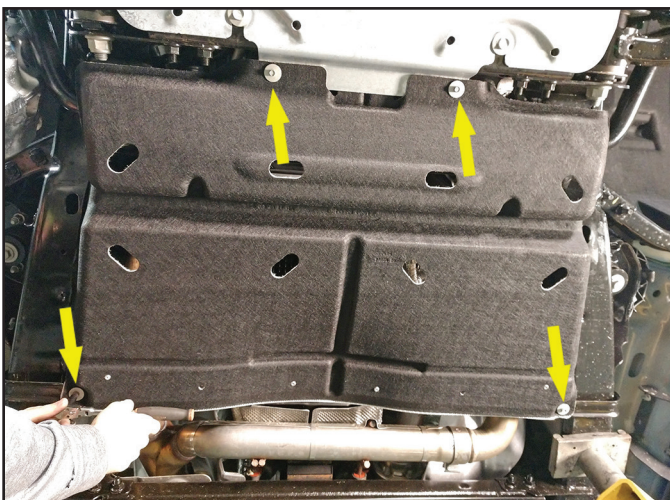
[Illustrations 11 & 12] Remove the nuts from the upper and lower ball joints then using the appropriate puller tool, disconnect the ball joints from the knuckle. If you do not have a puller tool you can use a hammer by very carefully striking the ball joint boss' of the knuckle; do not strike the ball joints. Remove knuckle from vehicle. [upper ball joint 18mm, lower ball joint 21mm]

**Illustration 11****Illustration 12****11) BRAKE LINE BRACKET...**

[Illustration 13] Locate the brake line bracket on the side of the upper control arm mount and remove. [10mm]

**Illustration 13****12) SPLASH GUARD...**

[Illustration 14] If equipped, remove the four bolts that hold the factory splash guard. Discard splash guard. [8mm]

**Illustration 14**



**13) FRONT DIFFERENTIAL SKID PLATE...**

[Illustration 15] If equipped, remove the four bolts that hold the factory front differential skid plate. Discard skid plate. [13mm]

**Illustration 15**



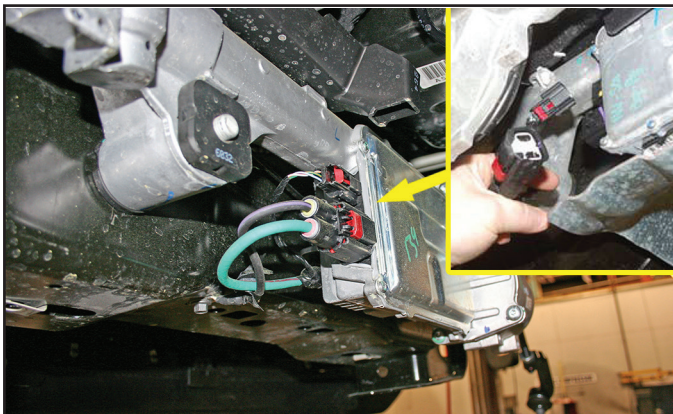
**14) ELECTRONIC POWER ASSIST STEERING (EPAS)...**

[Illustration 16] Remove the two (2) plugs connected to the Electronic Power Assist Steering (EPAS) located on the steering assembly by the front differential.

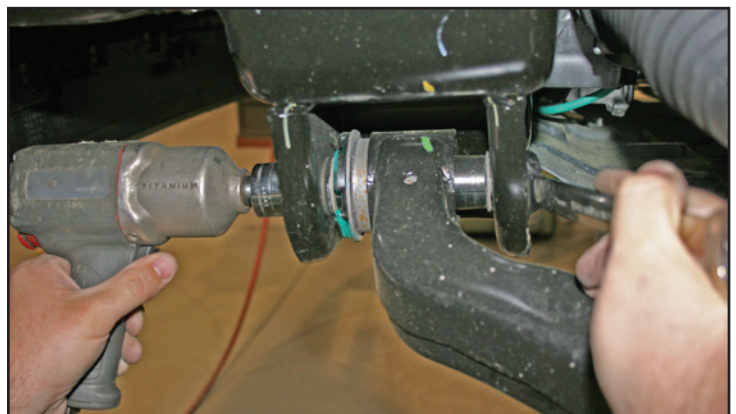
**15) LOWER CONTROL ARM...**

[Illustration 17] Loosen but do not remove the four lower control arm bolts (2 per side). [bolt 21mm, nut 27mm]

**Illustration 16**



**Illustration 17**



**16) STRUT...**

[Illustration 18] Remove the two nuts from the lower strut studs and let the lower control arm swing out of the way. [18mm]

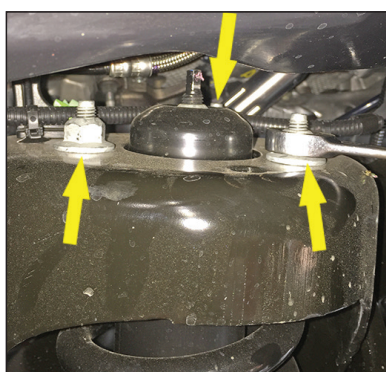
[Illustration 19 & 20] Remove the three nuts from the top of the strut and remove the strut from the vehicle. [18mm]

**Illustration 20**

**Illustration 18**



**Illustration 19**





**17) LOWER CONTROL ARM...**

[Illustration 21] Remove the lower control arm's bolts then remove the lower control arm.

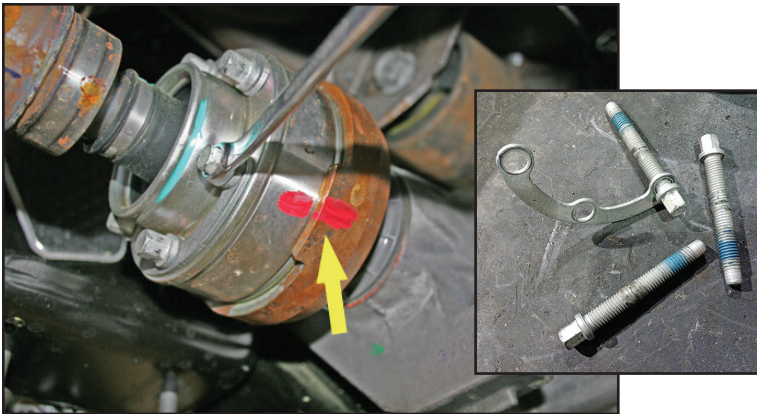
**REPEAT STEPS 3 THROUGH 17 ON THE REMAINING SIDE.**

**18) DRIVESHAFT...**

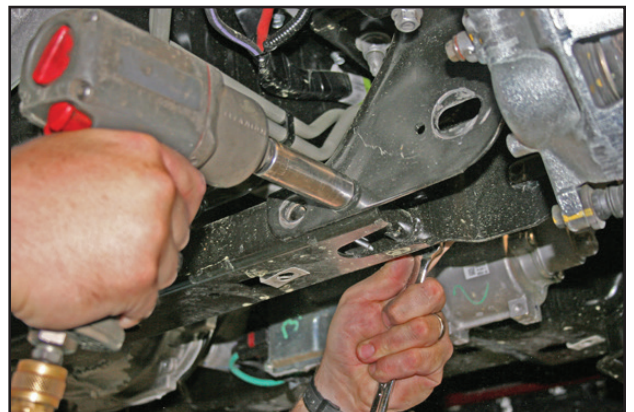
[Illustration 22] Mark the orientation of the front driveshaft, then disconnect from the differential; secure the driveshaft up and out of the way, do not let it hang. Retain washer plates. Discard the factory bolts (New bolts are supplied) [10mm]

**19) SWAY BAR BODY...**

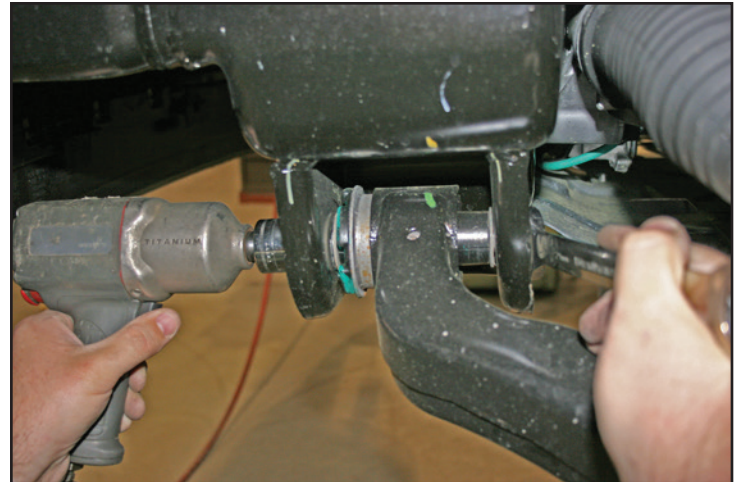
[Illustration 23] Remove four nuts retaining the sway bar body, then remove the sway bar from the vehicle. [15mm] Remove the stud plates from each side and retain for later use.

**Illustration 22****Illustration 23****20) REAR CROSSMEMBER...**

[Illustration 24] Remove the four bolts securing the rear crossmember and remove the rear crossmember. [bolt 15mm, nut 18mm]

**Illustration 24****21) DIFFERENTIAL VENT TUBE...**

[Illustration 25] Disconnect differential vent tube from differential located on the top of the center section towards the middle of the vehicle.

**Illustration 25****Illustration 21**

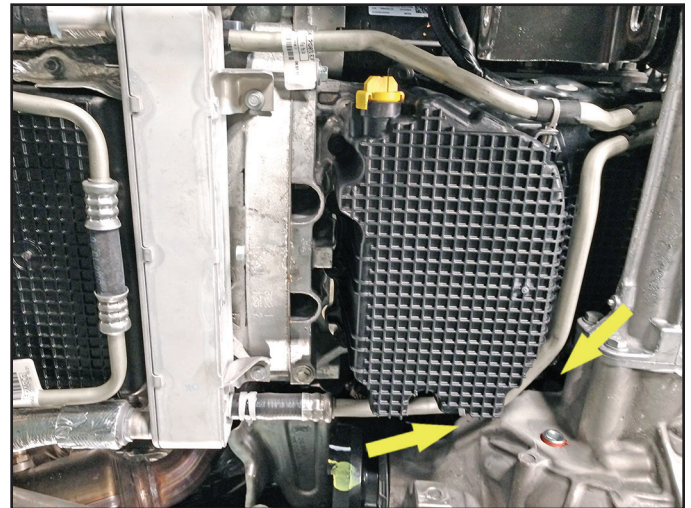


**⚠ WARNING:** The Driver side rear lower control arm/crossmember mount has to be trimmed on ALL models to allow clearance for the front driveshaft.) IF equipped with the second-generation 3.5-L EcoBoost V6 and the new 10R80 10-speed automatic transmission, this mount has to be trimmed BEFORE the differential can be removed due to the clearance in-between the differential and the oil pan. On other engines, the differential can be removed first, then the crossmember mount can be trimmed. [Illustrations 26]

IF equipped with the second-generation 3.5-L EcoBoost V6 and the new 10R80 10-speed automatic transmission, Proceed to Step 24.

Other Engine combinations, Proceed to Step 23.

**Illustration 26**



### 23) DIFFERENTIAL REMOVAL...

[Illustrations 27, 28, and 29] Support the differential with a jack and remove the rear driver's side differential bolt, then remove the two front bolts. [driver's side rear bolt 21mm, driver's side front bolt 18mm, passenger's side bolt 18mm]

Carefully remove differential assembly.

**Illustration 27**



**Illustration 28**



**Illustration 29**



### 24) TRIMMING LOWER CONTROL ARM MOUNT...

[Illustrations 30 thru 35] On the Driver Side lower control arm mount, start on the rear side and measure over 5-1/2" from the outer edge of the lower control arm mount and mark. Using a square, mark a line up and over the bracket maintaining the 5-1/2" distance from the inside edge. Repeat steps on the front side.

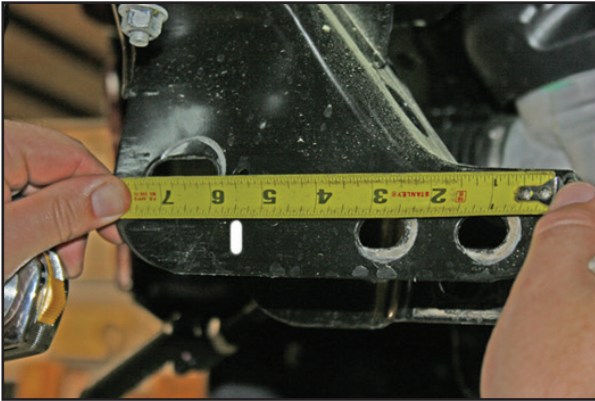
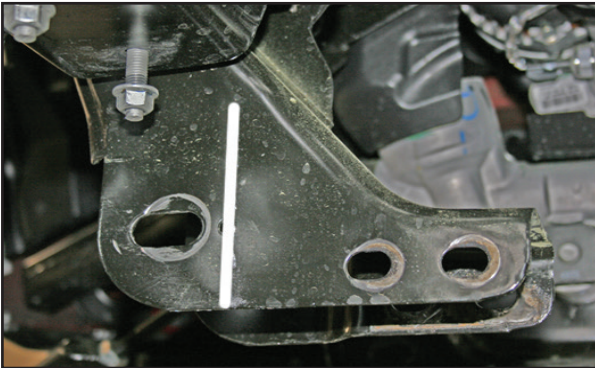
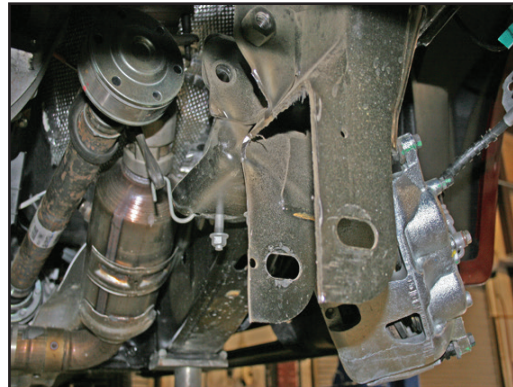
Make vertical cut lines at the marks on the front and back faces. Along the top, connect the front and back cut lines with a diagonal cut.



Using a torch, plasma cutter, reciprocating saw, cut-off wheel or similar tool, trim the Driver Side lower control arm bracket.

☐☐ Once you are happy with the cut, deburr the edges with a grinder and apply a coat of paint or undercoating to prevent rust.

**⚠ CAUTION:** When using a torch or plasma cutter, beware of the sticky, waxy undercoating - cosmoline. This will melt and drip during the cutting process. Take precautions to cover your person and the floor from this extremely HOT material.

**Illustration 30****Illustration 31****Illustration 32****Illustration 33****Illustration 34****Illustration 35**

**⚠ NOTE:** EcoBoost V6 applications proceed back to Step 23 DIFFERENTIAL REMOVAL...



## **FRONT ASSEMBLY**

### **21) DIFFERENTIAL INSTALLATION...**

□ [Illustration 36] Loosely attach the driver side front differential drop bracket (55-03-9930) to the differential using the supplied 9/16" x 3-3/4" hardware; install bolt from front. Do not tighten. **⚠ NOTE:** The offset will face the front of the vehicle. The 55-03-9930 bracket Does Not have Notches in the top.

□ [Illustration 37] Loosely attach the passenger side differential drop bracket (55-04-9930) to the frame using the factory hardware; install bolt from front. Do not tighten. **⚠ NOTE:** The offset will face the front of the vehicle. The 55-04-9930 bracket Has Notches in the Top.

□□ [Illustrations 38 & 39] Position the front driver differential bracket into the frame using the factory hardware; install bolt from front, then pivot the differential into the passenger side differential bracket and secure using the supplied 9/16" x 3-3/4" bolts, washer, and nut; install bolt from rear. Do not tighten.

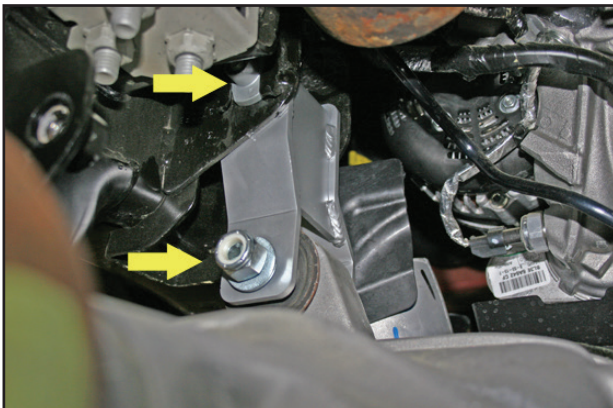
**Illustration 36**



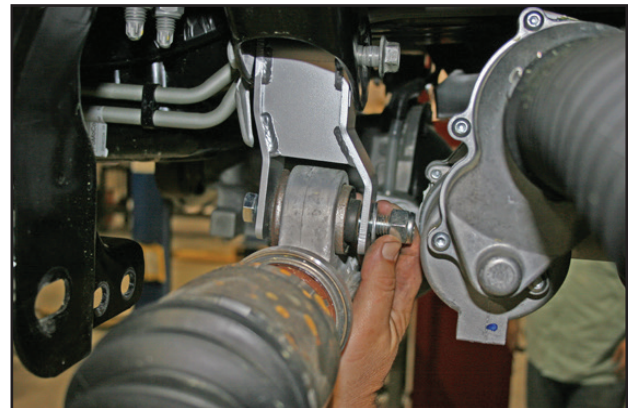
**Illustration 37**



**Illustration 38**

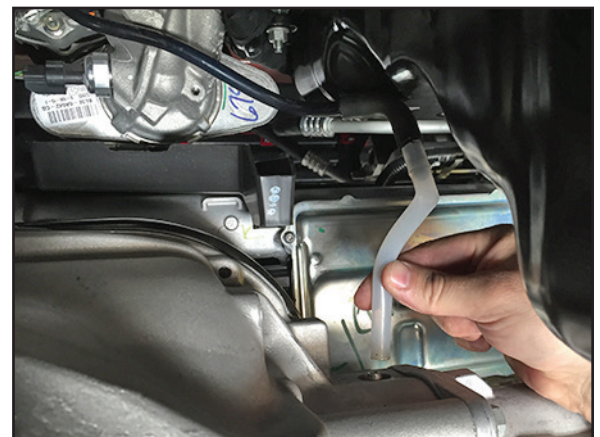


**Illustration 39**



□ [Illustration 40] Attach the hose adapter to the new vacuum hose, then attach the hose adapter to the factory hose. Connect the new hose to the differential.

**Illustration 40**



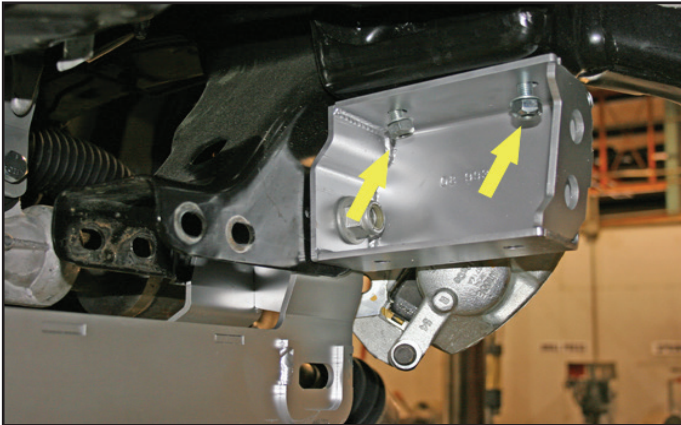


**22) SWAY BAR BRACKETS...**

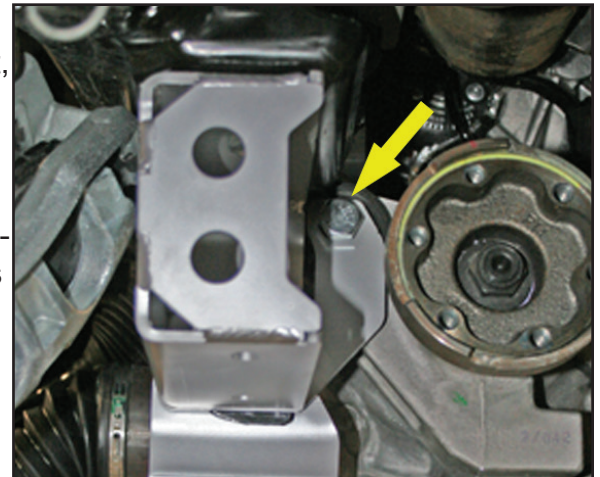
[Illustration 41] Position the sway bar brackets (55-07-9930 driver; 55-08-9930 passenger) on the frame using the supplied 7/16" x 1" bolts, washers, and nuts. Do not tighten.

**23) REAR CROSSMEMBER...**

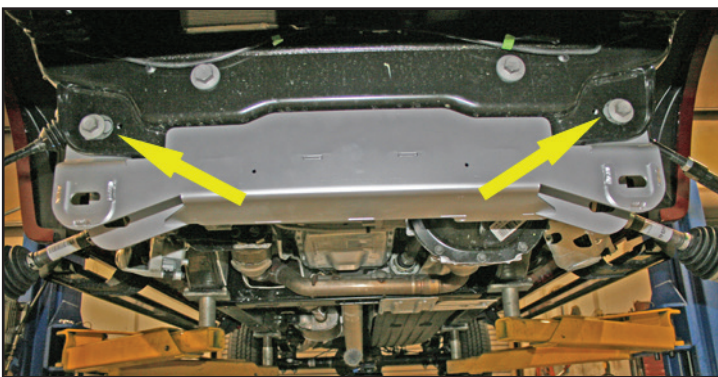
[Illustration 42] Raise the rear crossmember (55-06-9930) into position. Secure it to the frame using the supplied 18mm x 150mm bolts, washers, and nuts; install bolts from rear.

**Illustration 41****Illustration 42****24) DIFFERENTIAL REAR MOUNT...**

[Illustration 43] Install the supplied 9/16" x 3-3/4" bolt, washer, and nut from the rear, through the sway bar bracket, differential rear mount and the rear crossmember. Do not tighten.

**Illustration 43****25) FRONT CROSSMEMBER...**

[Illustration 44] Position the front crossmember (55-05-9930) into the frame using the factory hardware; install bolts from front. Do not tighten.

**Illustration 44****Illustration 45****26) LOWER CONTROL ARMS...**

[Illustration 45] Install the lower control arms into the new crossmembers with the supplied alignment cam bolts and nuts. Make sure the cam washers fit between the control tabs on the crossmembers. The cam washer should be in the up or neutral position. Snug but do not tighten. [27mm]

**27) TIGHTEN THESE FASTENERS...**

Tighten these bolts in this order. Refer back to the illustrations listed if needed.

- [Illustration 41] Snug sway bar drop brackets to frame; do not tighten. [bolt 5/8", nut 11/16"]
- [Illustration 39] Rear crossmember mounting bolts to frame. (280) [27mm]
- [Illustration 43] Differential rear mounting bolt to rear crossmember. (105) [bolt 13/16", nut 7/8"]
- [Illustration 37 & 38] Front differential brackets to frame. (130) [18mm]
- [Illustration 38 & 39] Front differential brackets to differential. (105) [bolt 13/16", nut 7/8"]
- [Illustration 41] Sway bar brackets to frame. (50) [bolt 5/8", nut 11/16"]
- [Illustration 44] Front crossmember to frame (280) [bolt 21mm, nut 27mm]

**28) BELLY PAN...**

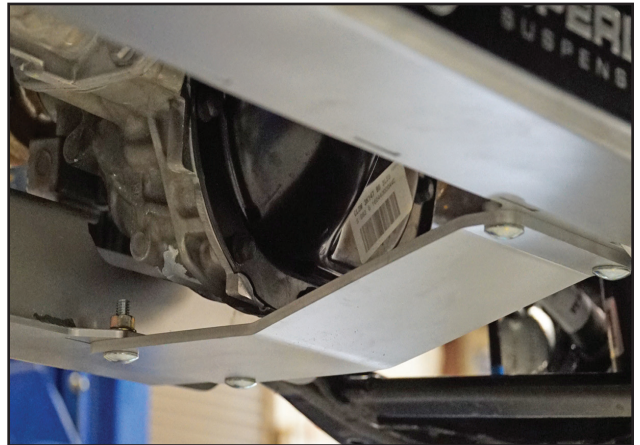
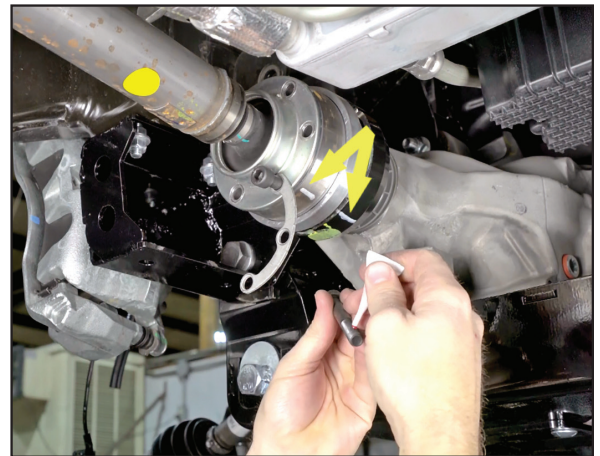
- [Illustration 46] Install the belly pan (55-10-9930) to the front and rear crossmembers using the supplied 3/8" x 1" bolts and nuts. Tighten (23) [9/16"]

**29) FRONT DRIVESHAFT...**

- [Illustration 47] Locate the front driveshaft spacer (66-11-9910). Align driveshaft spacer with driveshaft flange. Apply thread locker to the supplied 10mm x 90mm socket head bolts and install with factory washer plates. **⚠ NOTE:** Make sure that the orientation marks that were made previously are aligned. Tighten (63) [8mm allen]

**30) SWAY BAR...**

- [Illustration 48] Attach the sway bar body to the new drop brackets using the factory hardware. Tighten (55) [15mm]

**Illustration 48****Illustration 46****Illustration 47**



Perform steps 31 through 44 one side at a time.

### 31) STRUT SPACERS...

☐☐ [Illustration 49] Position the strut spacers (4.5" lift = 55-11-9930 or 6" lift = 55-09-9930) to the top of the factory strut and fasten using the factory hardware. Tighten (55) [18mm]

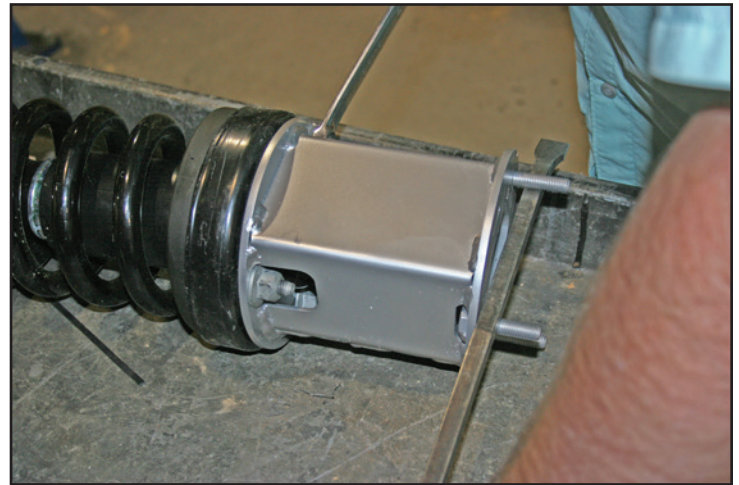
### 32) STRUTS...

☐☐ [Illustration 50] Install the strut assembly into the strut mount and attach using the supplied 10mm flange nut, start nut but do not tighten.

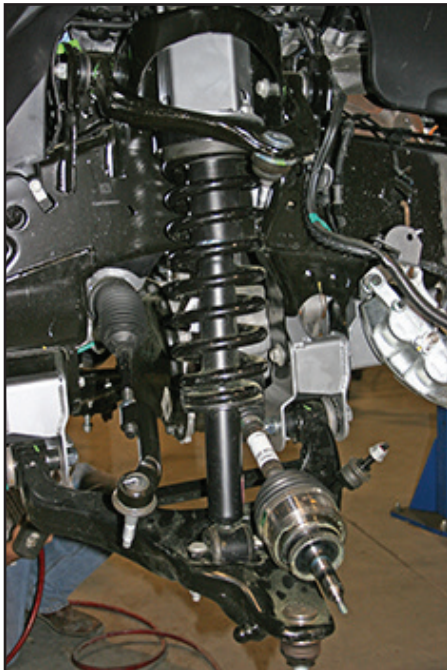
☐☐ [Illustration 51] Re-attach the lower strut mount to the lower control arm using the factory hardware and hand tighten. (80) [18mm]

☐☐ [Illustration 52] Tighten the three top strut spacer 10mm flange nuts. (55) [15mm]

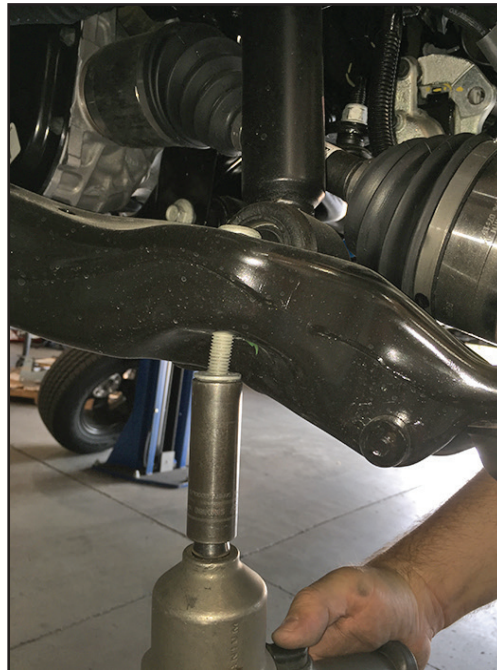
**Illustration 49**



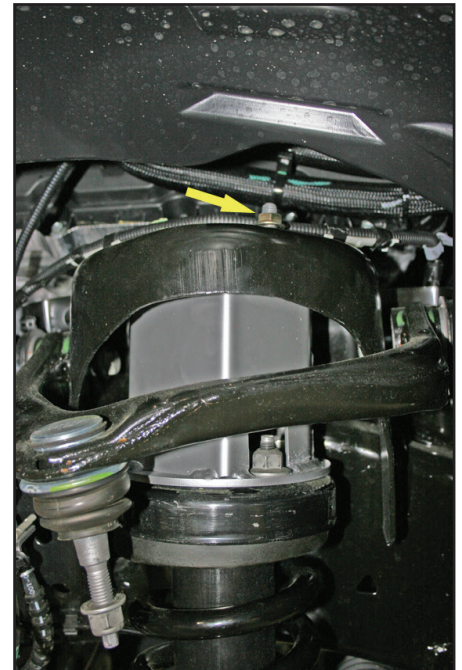
**Illustration 50**



**Illustration 51**



**Illustration 52**

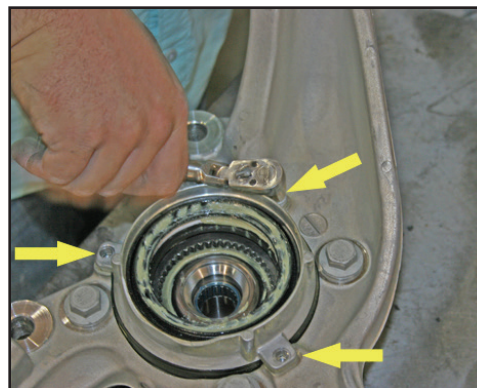


### 33) HUB ASSEMBLY AND VACUUM MODULE...

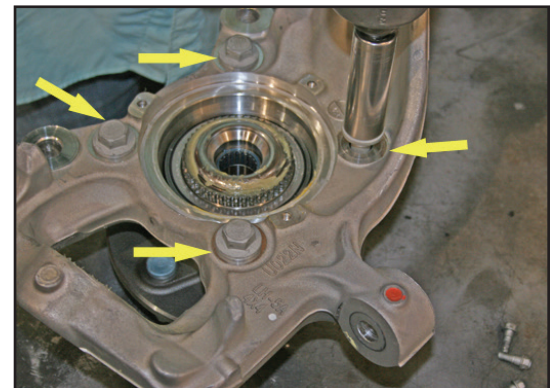
☐☐ [Illustration 53 & 54] On the factory knuckle, note the orientation of the vacuum module and hub bearing assembly, then remove them from the factory knuckle.

There are three (3) 8mm securing the vacuum assembly and four (4) 18mm bolts securing the hub bearing assembly.

**Illustration 53**



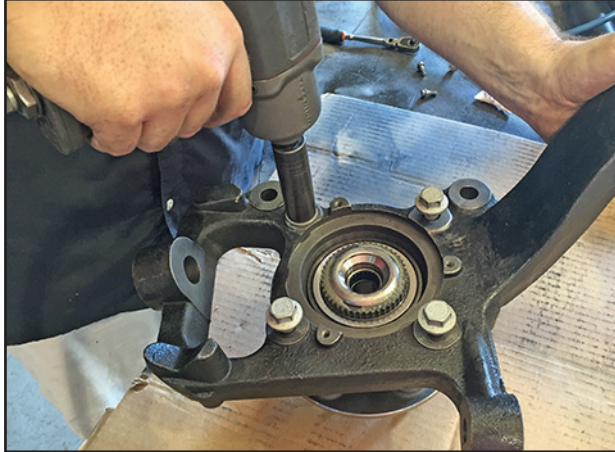
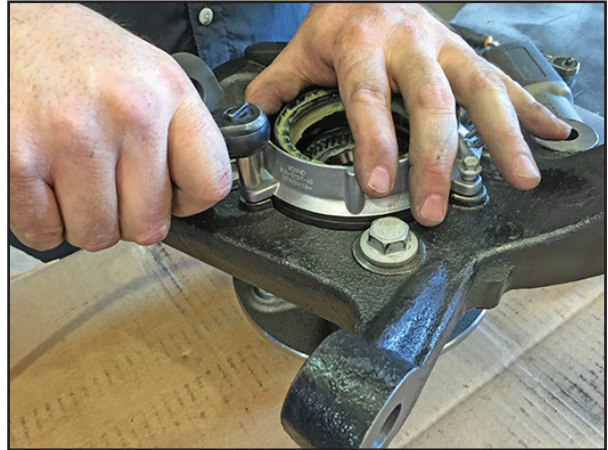
**Illustration 54**





☐☐ [Illustration 55] Install the new knuckle (66-01-9930 driver's side and 66-02-9930 passenger's side) onto the hub bearing assembly. Apply thread locker to the factory hardware and install bolts; tighten. (151) [18mm]

☐☐ [Illustration 56] Position the vacuum assembly on the knuckle and secure using the factory hardware; tighten. (10) [8mm]

**Illustration 55****Illustration 56****34) LOWER BALL JOINT...**

☐☐ [Illustration 57] Position the new knuckles on the lower control arm ball joint while sliding the CV shaft into the new knuckle. Snug tight lower ball joint nut. [21mm]

**35) CV SHAFT...**

☐☐ [Illustration 58] Pay close attention to the CV shaft engagement and make sure it is fully seated in the hub assembly. Install the factory nut onto the lower control arm ball joint. (20) [13mm]

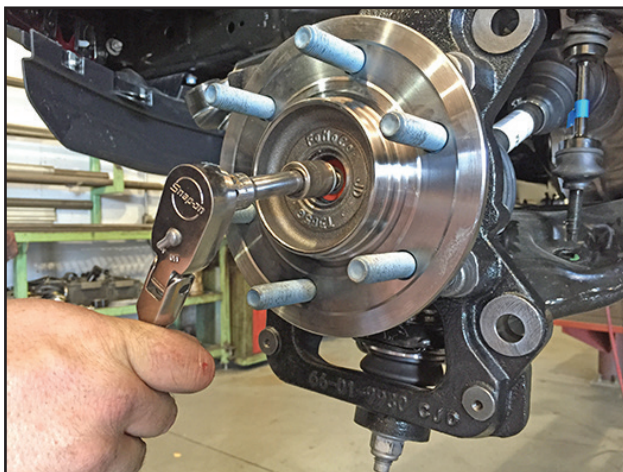
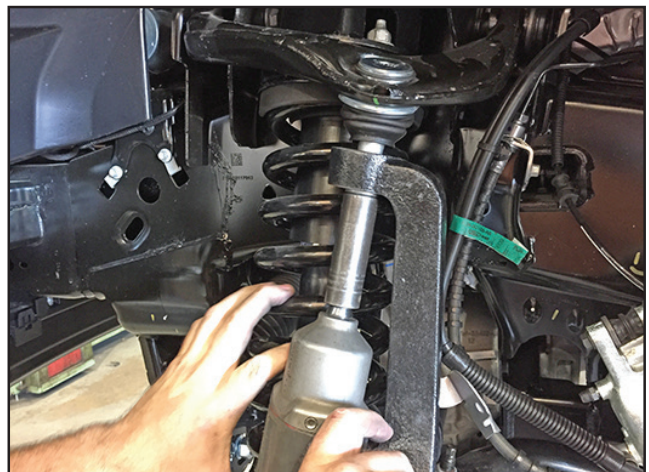
**36) UPPER BALL JOINT...**

☐☐ [Illustration 59] Attach the upper ball joint to the knuckle and snug tighten. [18mm]

**Illustration 57**

Tighten and torque lower ball joint nut. (111) [21mm]

Tighten and torque upper ball joint nut. (103) [18mm]

**Illustration 58****Illustration 59**



**37) LOWER STRUT MOUNT...**

[Illustration 51] Tighten and torque the lower strut mount nuts. (80) [18mm]

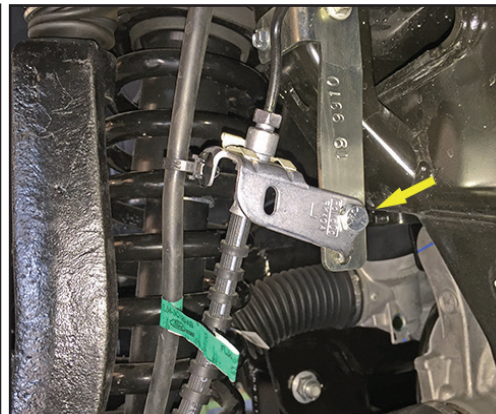
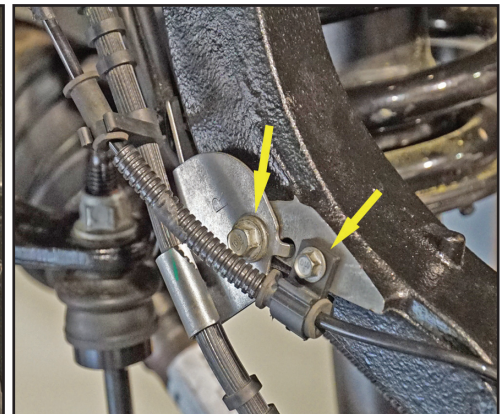
**38) BRAKE LINE BRACKETS...**

[Illustration 60] Install the new brake line brackets (55-19-9910 driver's side and 55-18-9910 passenger's side) on the frame using the factory hardware. (18) [10mm]

[Illustration 60 & 61] Use the bracket as a template to drill a 7/32" hole and install the 1/4" x 1/2" self-tapping bolt. (6.3) [3/8"]

[Illustration 62] Remove the ABS sensor wire from the clips holding it to the brake line bracket. Carefully bend the brake lines to re-attach the factory brake line bracket to the new one using the supplied 5/16" x 3/4" bolt, washer, and nut. (13) [1/2"] Do not kink the lines.

[Illustration 63] Connect brake line bracket to the steering knuckle using the factory hardware. (18) [10mm]

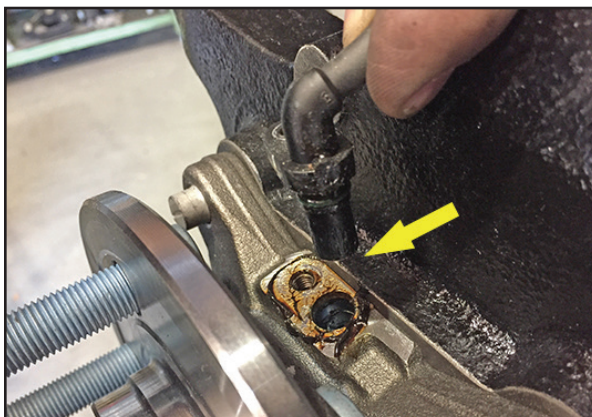
**Illustration 60****Illustration 61****Illustration 62****Illustration 63****39) ABS SENSOR AND VACUUM LINES...**

[Illustration 64] Make sure the ABS sensor line is free from the brake line and the vacuum line. Connect the ABS sensor to the hub assembly and tighten. (1) [5mm allen]

[Illustration 65] Connect the vacuum lines to the vacuum module.

**40) ABS SENSOR WIRE...**

[Illustration 63] Connect the ABS sensor wire to the knuckle using the factory hardware. (9) [8mm] Make sure the wire is positioned below the bolt.

**Illustration 64****Illustration 65**



**41) DUST SHIELD...**

[Illustration 66] Install the dust shield and secure using the factory hardware; tighten. (7.5) [8mm]

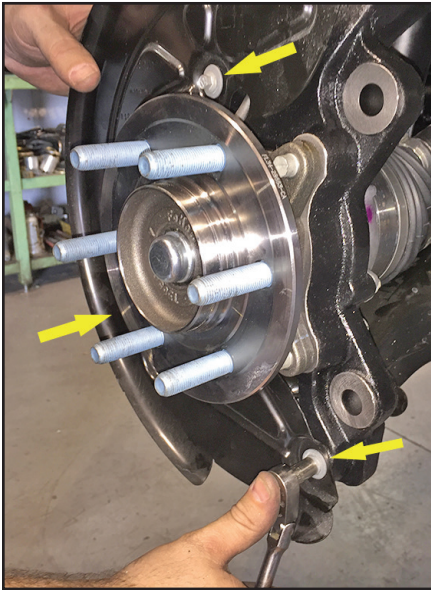
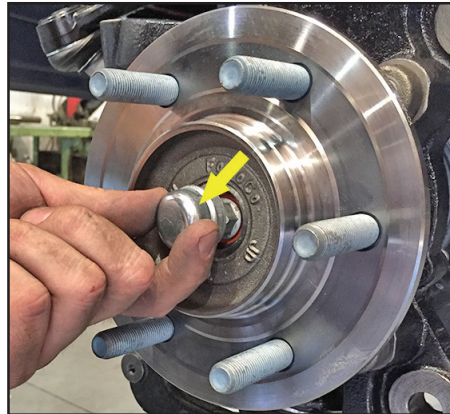
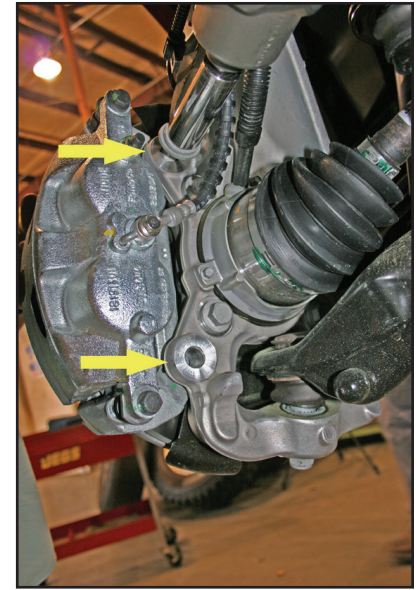
**42) CV AXLE DUST CAP...**

[Illustration 67] Install dust cap. Tap into place. [hammer]

**43) BRAKE CALIPERS...**

Install the rotor. **TECH TIP:** Installing a factory lug nut will help hold the rotor in position to install the caliper.

[Illustration 68] Apply thread locker to the factory bolts then position the caliper over the rotor and install the factory hardware and tighten. (159) [21mm]

**Illustration 66****Illustration 67****Illustration 68****44) STEERING TIE ROD END...**

[Illustration 69] Attach the tie rod end to the knuckle; tighten. (136) [21mm]

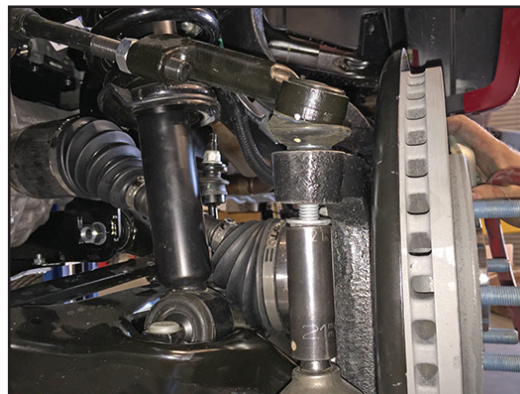
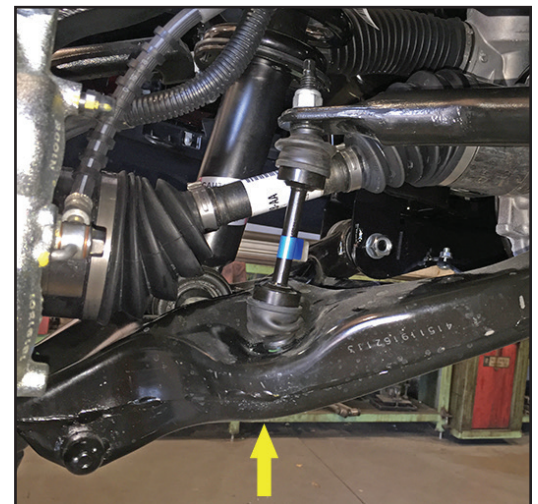
**Perform step 31 through 44 on the remaining side.**

**45) SWAY BAR LINKS...**

[Illustration 70] Connect the sway bar links to the lower control arm; tighten. (63) [15mm]

**46) ELECTRONIC POWER ASSIST STEERING (EPAS)...**

[Illustration 16] Reconnect the two (2) plugs to the Electronic Power Assist Steering (EPAS) located on the steering assembly by the front differential.

**Illustration 69****Illustration 70**

**47) TIRES / WHEELS...**

[Illustration 71] Install tires and wheels. Tighten the lug nuts in a 'star' sequence shown. (151) [21mm]

**⚠ WARNING:** When the tires / wheels are installed, always check for and remove any corrosion, dirt, or foreign material on the wheel-mounting surface, or anything that contacts the wheel-mounting surface (hub, rotor, etc.). Installing wheels without the proper metal-to-metal contact at the wheel mounting surfaces can cause the lug nuts to loosen and the wheel to come off while the vehicle is in motion.

**🚫 CAUTION:** Retighten lug nuts at 500 miles, after any wheel change, or anytime the lug nuts are loosened. Failure to do so could cause wheels to come off while vehicle is in motion.

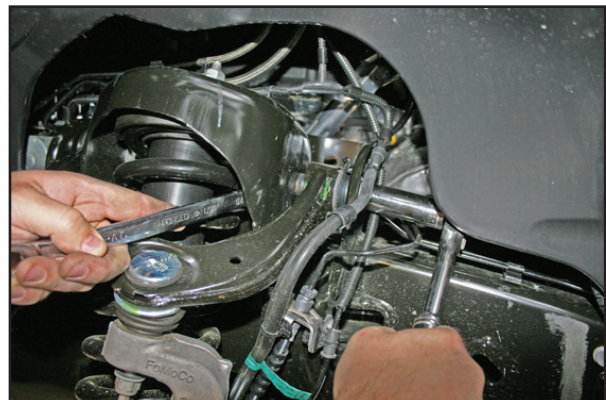
Lower vehicle to the floor. The suspension is now supporting vehicle weight.

**48) LOWER CONTROL ARM...**

[Illustration 72] Tighten the four lower control arm bolts (2 per side); keep the alignment cams in the up (neutral) position until the alignment is performed. (240) [27mm]

**49) UPPER CONTROL ARM...**

[Illustration 73] Tighten the four upper control arm bolts (2 per side). (151) [bolt 18mm, nut 21mm]

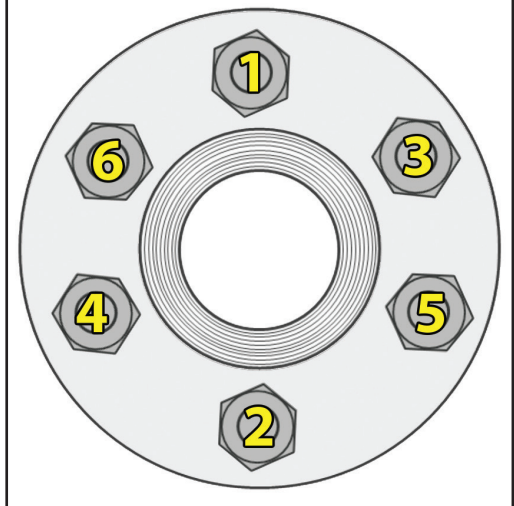
**Illustration 72****Illustration 73****50) CLEARANCE CHECK...**

With the vehicle on the ground, cycle the steering lock-to-lock and check all components for proper operation and clearances. Pay special attention to the clearance between the tires / wheels and knuckles, brake hoses, wiring, etc.

Raise the vehicle back onto jack stands and secure as per step 1. With the suspension "hanging" at full extension travel, cycle the steering lock-to-lock and check all components for proper operation and clearances. Pay special attention to the clearance between the tires / wheels and knuckles, brake hoses, wiring, etc. Lower the vehicle to the floor.

**Illustration 71****Lug Nut Torque Sequence...**

**Follow the Sequence Below to Torque the Lug Nuts**





## **REAR DISASSEMBLY**

### **51) RAISE REAR OF VEHICLE...**

Chock the front tires. Position a jack beneath the center of the rear axle then raise rear of vehicle. Secure jack stands beneath the frame rails just forward of the rear springs. Remove rear tires. [21mm]

### **52) SHOCK ABSORBERS...**

[Illustration 74 & 75] Remove shock absorbers - upper & lower mounts. [bolt 15mm, nut 18mm]

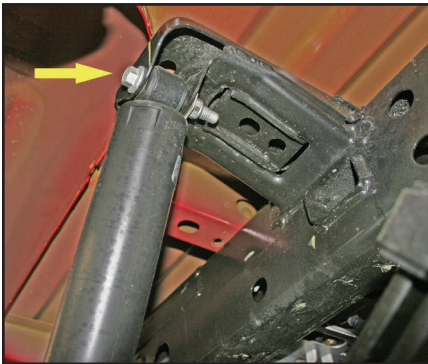
### **53) BRAKE LINE BRACKET...**

[Illustration 76] Locate the factory rear brake line connection where the hard brake lines connect to the brake hoses on the Driver side inner frame rail near the bump stop mount. Un-bolt the factory brake line mounting bracket from the frame. [10mm] Un-clip the axle vent hose from the bed.

### **54) AXLE VENT HOSE...**

[Illustration 76] Un-clip the axle vent hose from the bottom of the truck bed.

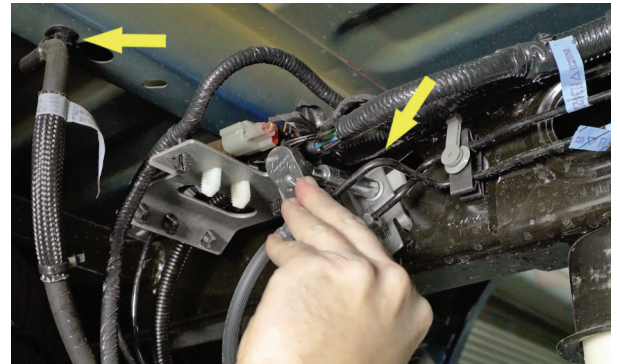
**Illustration 74**



**Illustration 75**



**Illustration 76**



### **55) BUMP STOP...**

[Illustration 77] Remove the rear bump stops from the frame. [13mm]

### **56) UBOLTS AND BLOCKS...**

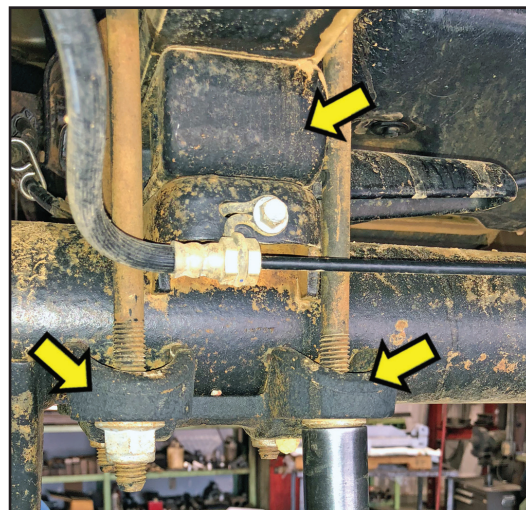
[Illustration 78] Remove ubolts and then lower the axle several inches away from springs. [21mm] Discard the ubolts and hardware. Maintain the lower ubolt plate.

Clean spring pads of all debris.

**Illustration 77**



**Illustration 78**





## REAR ASSEMBLY

### 57) LIFT BLOCKS AND UBOLTS...

**FOR the 4.5" LIFT** - Locate the SUPERLIFT (2) 55-30-9930 rear blocks. Locate the (4) #10342 - 9/16" x 3-5/16" x 10" square ubolts.

**FOR the 6" LIFT** - Locate the SUPERLIFT (2) 55-31-9930 rear blocks. Locate the (4) #10352 - 9/16" x 3-5/16" x 11" square ubolts.

Locate Hardware Bag #77-1509. Hardware PER Side: (4) 9/16" high nut, fine thread & (4) 9/16" ubolt washers.

☐☐ [Illustration 79] Position the appropriate SUPERLIFT block for the desired lift on top of the axle pad. **NOTE:** The 'notched' edge of the block goes toward the 'front'.

☐☐ Using the floor jack(s), mate the springs to the blocks, be sure that the center bolt heads seat properly. Install the new SUPERLIFT 9/16" u-bolts, factory ubolt plate and supplied ubolt washers & high nuts. Evenly torque the ubolts using an "X" tightening sequence. (150) [7/8"]

Illustration 79

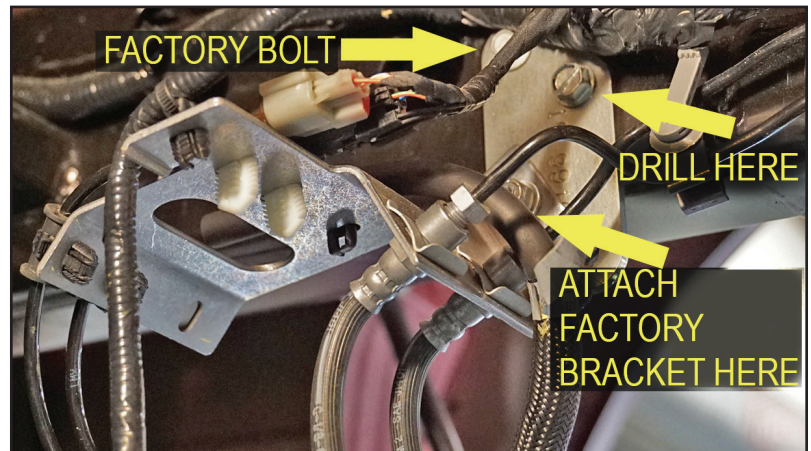


### 58) BRAKE LINE BRACKET...

☐☐ [Illustration 80] Install the new brake line extension bracket (55-16-9910) to the frame using the factory hardware. (26) [10mm]

☐☐ [Illustration 80] Use the bracket as a template to drill a 9/32" hole and install the 5/16" x 1" self-tapping bolt. (13) [1/2"] Make sure the new hole is below and forward of the factory hole in the frame.

Illustration 80



☐ [Illustration 80] Carefully bend brake lines to attach the factory brake line bracket to the new bracket using the supplied 5/16" x 1" bolt, washer, and nut. (13) [1/2"] Do not kink the lines.

### 59) AXLE VENT HOSE...

☐ [Illustration 81] Attach the vent hose to the top of the factory brake line bracket.

### 60) EMERGENCY BRAKE BRACKET...

☐ [Illustration 82 & 83] Locate the factory brake line bracket that is retaining the Driver side cable at the front rear spring hanger. Using a pair of pliers carefully bend the bracket down.



Illustration 81

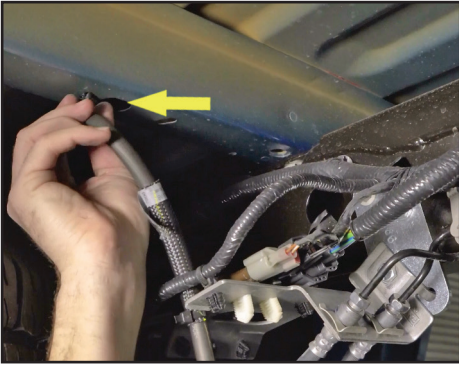


Illustration 82



Illustration 83



### 61) SHOCK ABSORBERS...

Install the supplied hourglass bushings into the shock eyes. Then install the #24-5704, 0.75" OD x 0.50" ID x 1.54" L, sleeves into the shock eyes.

[Illustration 84] Attach shocks (01-85150 SUPERIDE or BE5-6249-H5 BILSTEIN 5100 SERIES) to vehicle using the factory hardware. (55) [bolt 15mm, nut 18mm]

**▲NOTE:** The SUPERLIFT Shock Has to Be Installed with body of the shock positioned on the axle end. (Remember, **Shaft Up, Body Down.**)

BILSTEIN can be mounted Shaft Up or Shaft Down.

### 62) BUMP STOPS...

[Illustration 85] Position the new bump stop spacers (55-12-9930) on top of the factory bump stop and attach the frame using the supplied 10mm x 150mm bolt and washer. (40) [17mm]

Illustration 84

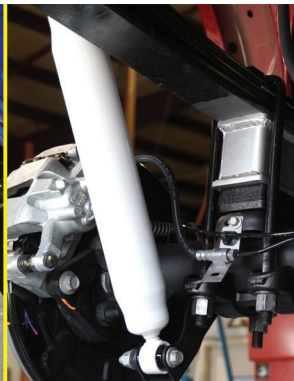
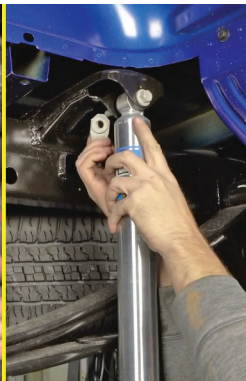
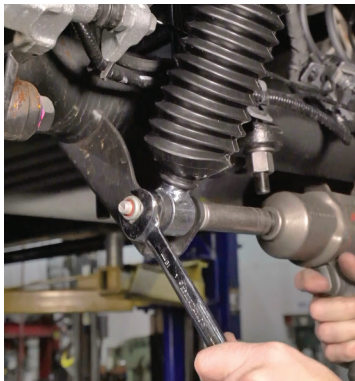


Illustration 85



### 63) TIRES / WHEELS...

[Illustration 71] Reinstall tires and wheels. Tighten the lug nuts in the sequence shown. (151) [21mm]

**▲WARNING:** When the tires / wheels are installed, always check for and remove any corrosion, dirt, or foreign material on the wheel mounting surface, or anything that contacts the wheel mounting surface (hub, rotor, etc.). Installing wheels without the proper metal-to-metal contact at the wheel mounting surfaces can cause the lug nuts to loosen and the wheel to come off while the vehicle is in motion.

**▲WARNING:** Retighten lug nuts at 500 miles, after any wheel change, or anytime the lug nuts are loosened. Failure to do so could cause wheels to come off while vehicle is in motion.

Lower vehicle to the floor.

## **FINAL CHECKS**

### **64) CLEARANCE CHECK...**

- Check all hardware for proper torque specifications.

With the vehicle on the ground, check all components for proper operation and clearances. Pay special attention to the clearance between the tires / wheels, brake hoses, wiring, etc. Check tire/wheel clearance with the fenders/bumper as well as with the steering knuckle.

**⚠ NOTE:** Depending on your choice of tire size and wheel width, it is not uncommon to trim the lower plastic valance of the bumper and inner fender shroud slightly to add proper tire clearance while turning.

### **65) WHEEL ALIGNMENT...**

- Realign vehicle to factory OEM specifications. It is necessary to have a proper and professional wheel alignment performed by a certified alignment technician. Align the vehicle to factory specifications. It is recommended that your vehicle alignment be checked after any off-road driving.

### **66) HEADLIGHTS...**

- Re-adjust headlights to proper setting. In addition to your vehicle alignment, for your safety and others, it is necessary to check and adjust your vehicle headlamps for proper aim and alignment.

### **67) FOUR WHEEL DRIVE...**

- Activate the four wheel drive system and check for proper engagement.

### **68) SUPERLIFT WARNING DECAL...**

- Install the **WARNING TO DRIVER** decal on the inside of the windshield, or on the dash, within Driver's view.

## **IMPORTANT MAINTENANCE INFORMATION**

**⚠ WARNING:** It is the ultimate buyer's responsibility to have all bolts / nuts checked for tightness after the first 100 miles and then every 1000 miles. The steering, suspension and driveline systems, plus wheel alignment should be inspected by a qualified professional mechanic at least every 3000 miles.

## **LIMITED LIFETIME WARRANTY / WARNINGS**

Your SUPERLIFT® product is covered by the Limited Warranty explained below that gives you specific legal rights. This limited warranty is the only warranty SUPERLIFT® makes in connection with your product purchase. SUPERLIFT® neither assumes nor authorizes any retailer or other person or entity to assume for it any other obligation or liability in connection with this product or limited warranty.

### **SUPERLIFT, LLC, LIMITED LIFETIME WARRANTY**

What is covered? Subject to the terms below, SUPERLIFT® will repair or replace its products found defective in materials or workmanship for so long as the original purchaser owns the vehicle on which the product was originally installed. Your warranter is SUPERLIFT, LLC, doing business as SUPERLIFT® Suspension Systems ("SUPERLIFT®").



What is not covered? Your SUPERLIFT® Limited Warranty does not cover products SUPERLIFT® determines to have been damaged by or subjected to:

- Alteration, modification or failure to maintain.
- Normal wear and tear (bushings, rod ends, etc.). Scratches or defects in product finishes (powder coating, plating, etc.).
- Damage to, or resulting from, the vehicle's electronic stability system, related components or other vehicle systems.
- Racing or other vehicle competitions or contests. Accidents, impact by rocks, trees, obstacles or other aspects of the environment.
- Theft, vandalism or other intentional damage.

Remedy Limited to Repair or Replacement. The exclusive remedy provided hereunder shall, upon SUPERLIFT's inspection and at SUPERLIFT's option, be either repair or replacement of the product covered under this Limited Warranty. Customers requesting warranty consideration should contact SUPERLIFT® by phone (1-800-551-4955) to obtain a Returned Goods Authorization number. All removal, shipping and installation costs are customer's responsibility.

If a replacement part is needed before the SUPERLIFT® part in question can be returned, you must first purchase the replacement part. Then, if the part in question is deemed warrant-able, you will be credited / refunded.

#### **OTHER LIMITATIONS - EXCLUSION OF DAMAGES - YOUR RIGHTS UNDER STATE LAW**

- Neither SUPERLIFT® nor your independent SUPERLIFT® dealer are responsible for any time loss, rental costs, or for any incidental, consequential or other damages you may have.
- This Limited Warranty gives you specific rights, and this is the only warranty SUPERLIFT® makes in connection with your product purchase. You may also have other rights that vary from state to state. For example, while all implied warranties are disclaimed herein, any implied warranty required by law is limited to the terms of our Limited Lifetime Warranty as described above. Some states do not allow limitations of how long an implied warranty lasts and / or do not allow the exclusion or limitation of incidental or consequential damages, so the limitations and exclusions herein may not apply to you. SUPERLIFT® neither assumes nor authorizes any retailer or other person or entity to assume for it any other obligation or liability in connection with this product or Limited Warranty.

#### **IMPORTANT PRODUCT USE AND SAFETY INFORMATION / WARNINGS**

**⚠️WARNING:** As a general rule, the taller a vehicle is, the easier it will roll over. Offset, as much as possible, what is lost in rollover resistance by increasing tire track width. In other words, go "wide" as you go "tall"; always use as wide a tire and wheel combination as feasible to enhance vehicle stability. We strongly recommend, because of rollover possibility, that the vehicle be equipped with a functional roll bar and cage system. Seat belts and shoulder harnesses should be worn at all times. Avoid situations where a side rollover may occur.

Generally, braking performance and capabilities are decreased when significantly larger / heavier tires and wheels are used. Take this into consideration while driving. Also, changing axle gear ratios or using tires that are taller or shorter than factory height will cause an erroneous speedometer reading. On vehicles equipped with an electronic speedometer, the speed signal impacts other important functions as well. Speedometer recalibration for both mechanical and electronic types is highly recommended.

Do not add, alter, or fabricate any factory or aftermarket parts to increase vehicle height over the intended height of the SUPERLIFT® product purchased. Mixing component brands is not recommended.

**WE WANT TO SEE YOUR RIDE...**

Grab photos of your SUPERLIFT Equipped truck in various poses and in action.

Email pictures to us at [sales@superlift.com](mailto:sales@superlift.com)

Tag us on **Facebook:** [@superlift suspension systems](https://www.facebook.com/superlift.suspension.systems)

Tag us on **Instagram:** [#superlift](https://www.instagram.com/superlift), [#superliftsuspension](https://www.instagram.com/superliftsuspension), [#superliftequipped](https://www.instagram.com/superliftequipped)

**THANKS For Choosing SUPERLIFT...**

For questions, technical support and warranty issues relating to this SUPERLIFT products, please contact SUPERLIFT directly.

**SUPERLIFT SUSPENSION  
300 Huey Lenard Loop Rd.  
West Monroe, Louisiana 71292  
Phone: (318) 397-3000  
Sales / Tech: (800) 551-4955  
Fax: (318) 397-3040  
SUPERLIFT.COM**